

KONICA MINOLTA

bizhub 225i
QUICK GUIDE

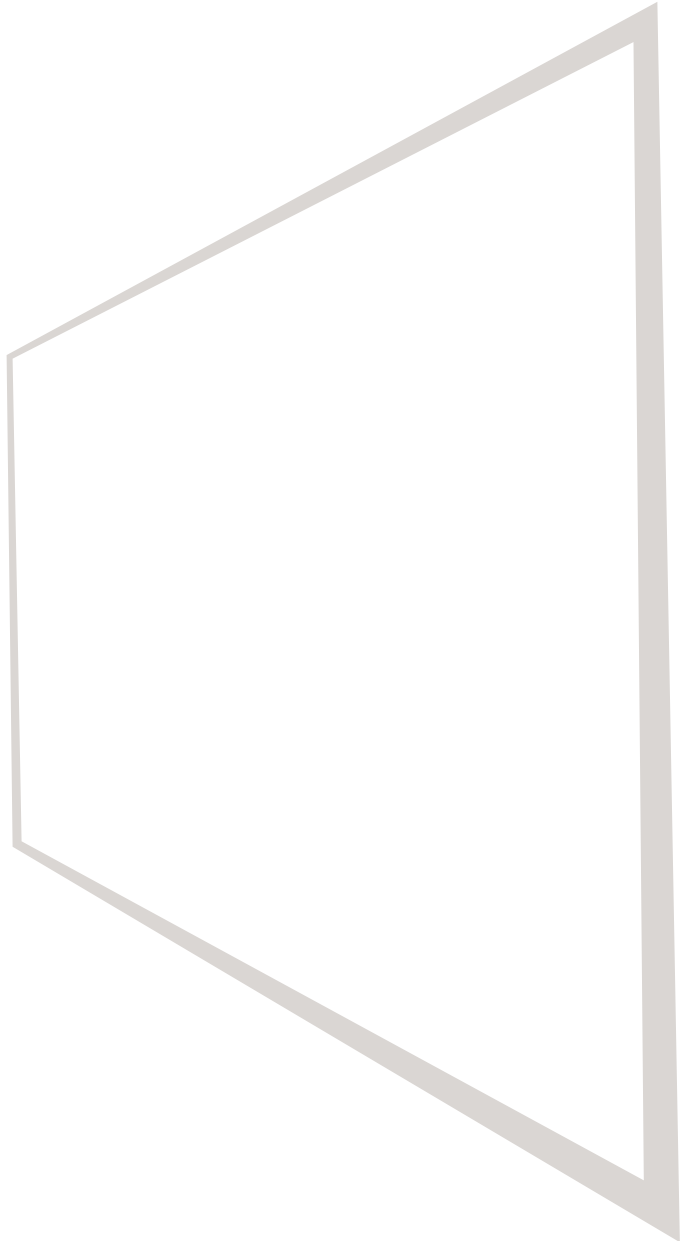

Giving Shape to Ideas

Table of contents

1 Introduction

1.1	Environmental information	1-4
	Environmental benefits of power management	1-4
	Recycled paper	1-4
	Duplex printing	1-4
1.2	Safety information	1-5
	Warning and precaution symbols	1-5
	These are some of major exemplary graphical symbols	1-5
	Power source connection	1-5
	Installation	1-7
	Using the product	1-8
	Consumables	1-9
1.3	Regulation notices	1-10
	About certified model name.....	1-10
	CE Marking (Declaration of Conformity) for users of the European Union (EU).....	1-10
	GS Certification	1-10
	Laser safety	1-10
	Internal laser radiation.....	1-11
	CDRH regulations	1-11
	For European users.....	1-11
	Laser safety label	1-12
	Ozone release	1-12
	Acoustic noise (for German users only)	1-12
	For EU member states only	1-12
	Graphic symbols used on this machine.....	1-13
1.4	Caution notations and labels	1-14
1.5	Special Notice to User	1-14
	For Europe	1-14
1.6	Space requirements	1-15
1.7	Operation precautions	1-16
	Power source	1-16
	Operating environment	1-16
	Storage of copies.....	1-16
1.8	Legal restrictions on reproduction	1-17
1.9	Trademarks and copyrights	1-18
	OpenSSL License	1-18
	Kerberos.....	1-20
	OpenLDAP	1-22
	Cyrus SASL.....	1-23
	Smbfs	1-23
	DES part of SSLeay	1-24
	Wide DHCPv6	1-24
	OpenSLP	1-25
	lwIP	1-25
	FatFs License.....	1-26
	Copyright	1-26
	Note	1-26
1.10	SOFTWARE LICENSE AGREEMENT	1-27

2 About This Machine

2.1	About the User's Guide	2-3
	User's guides contained on the CD/DVD	2-3
2.2	Functions of this machine	2-4
	Copy function.....	2-5
	Printer function.....	2-5
	Fax function	2-5
	Network function.....	2-5
	Scan function	2-5
2.3	Control Panel	2-6
	Name and function of each component of the Control Panel	2-6
	Extended Operation Panel MK-750 (Option)	2-8
2.4	Operations on the Control Panel	2-9
	Specifying the zoom ratio	2-9
2.5	Turning the power on/off	2-10
	Turning on the power.....	2-10
	Turning off the power.....	2-10
2.6	Original Set	2-11
	Loading the original onto the Original Glass	2-11
	Loading the original into the ADF	2-12
2.7	Loading paper	2-13
	Loading paper into Tray 1	2-13
	Loading paper into Tray 2, Tray 3, Tray 4, or Tray 5 (optional).....	2-14
	Loading paper into the Bypass Tray	2-15
2.8	Removing a jam	2-16
	Removing a paper jam in the main unit, Bypass Tray, or Tray1	2-17
	Removing a paper jam in Tray 2, Tray 3, Tray 4, or Tray 5	2-18
	Removing a paper jam in the ADF	2-18
	Removing a jam in the Automatic Duplex Unit	2-19
2.9	Replacing consumables	2-20
	Replacing the Toner Bottle	2-20
2.10	Option configuration	2-22

3 Using as a Copy Machine

3.1	Copying an original	3-3
3.2	Enlarging or reducing the original to a different size	3-4
	Specifying the zoom ratio manually	3-4
3.3	Saving paper used for copying	3-5
	2-sided copying	3-5
	Combined copying.....	3-6
3.4	Copying on custom sized paper	3-7
	For Bypass tray	3-7
	For Tray 1	3-8
3.5	Making copies on envelopes	3-9
3.6	Canceling the ongoing copy operation	3-10

4 Using as a Fax Machine

4.1	Sending a fax	4-3
4.2	Sending a fax to multiple destinations at the same time	4-5
	Sequential broadcast transmission.....	4-5
4.3	Checking fax communication results	4-6
4.4	Registering frequently used fax destinations	4-7
	Registering destinations in One-touch Dial	4-7
	Registering destinations in the speed dial	4-8
4.5	Entering characters	4-10
	Entering characters using the Keypad	4-10
	List of characters that can be entered from the Keypad	4-10
	Entering more than one character	4-10



4.6	Canceling the ongoing transmission	4-11
4.7	Checking the registered destinations	4-12
4.8	Sending data in the computer directly as a fax without leaving the desk.....	4-13
	PC-FAX	4-13
4.9	If you suspect a failure then do the following	4-14
	Cannot send a fax correctly	4-14
	Cannot receive a fax correctly	4-15
	Cannot call correctly	4-15

5 Using as a Printer

5.1	Before Printing	5-3
5.2	Printing	5-3
	Printing data.....	5-3
5.3	Enlarging or reducing the original to fit the paper size.....	5-4
5.4	Saving paper used for printing	5-5
	2-sided printing	5-5
	Combined printing	5-6
5.5	Printing on custom sized paper.....	5-7
	When using the Bypass Tray	5-7
	When using Tray 1	5-10
5.6	Printing on envelopes	5-13
	When using the Bypass Tray	5-13
	When using Tray 1	5-16

6 Using as a Scanner

6.1	Sending scanned data	6-3
	Sending an E-mail	6-3
	Sending scanned data to the FTP/SMB server	6-5
6.2	Registering frequently used destinations.....	6-7
	Registering destinations in One-touch Dial	6-7
	Registering destinations in the speed dial	6-8
6.3	Canceling the ongoing transmission	6-10
6.4	How to use Scan to USB	6-11
6.5	Scanning using a TWAIN driver	6-13
6.6	Scanning using a WIA driver	6-14

7 Troubleshooting

	The power does not turn on.....	7-3
	A message prompting you to replace consumables has appeared	7-3
	The paper jam message does not disappear	7-4
	An error message has appeared.....	7-4

8 Utility

9 Index





Introduction

1 Introduction

This [Quick Guide] uses illustrations to describe operating procedures for the most commonly used functions in an easy-to-understand way.

Start by using this manual to become proficient with the useful functions that this machine offers.

For details on the various functions, refer to the User's Guides on the User's Guide CD/DVD included with this machine.

In order to operate the machine safely and properly, be sure to read the safety information on page 1-5 of this manual before use.

In addition, this manual contains the following information. Be sure to read the manual before using the machine.

- Items that must be observed to use the machine safely
- Information regarding product safety
- Precautions when using the machine
- Descriptions on trademarks and copyrights

The illustrations and screens used in this manual may appear slightly different from views of the actual equipment and screens.

Tips

Please keep this manual as well as the attached CD/DVD in a safe place where you can access them easily.

1.1 Environmental information

Environmental benefits of power management

Electricity consumption of a device depends on both its properties and the way of using the device.

Suitable power management setting offers you resource saving usage way. By setting the time to go into power saving modes (e.g. sleep mode) shorter (or optimal), electricity consumption can be reduced.

Recycled paper

This product can print on recycled paper and environmental stewardship initiatives certified paper which complies with European standard EN 12281 as well as virgin paper. In addition it can print on lighter paper, 64g/m² for example. Using such light paper contributes to resources-saving.

Duplex printing

With a product which has a duplex unit, you can print on both sides of paper automatically.

Using this function leads to reducing consumption of natural resources and your cost.

Attached printer driver provides this duplex printing function as initial setting in your computer (The setting can be changed after installation manually).

1.2 Safety information

This section contains detailed instructions on the operation and maintenance of this machine. To achieve optimum utility of this device, all operators should carefully read and follow the instructions in this manual.

Please read the following section before connecting the machine to the supply. It contains important information related to user safety and preventing equipment problems.

Make sure that you observe all of the precautions that appear in different sections of this manual.

Reference



- Some parts of the contents of this section may not correspond with the purchased product.

Warning and precaution symbols









Be sure to observe the safety precautions.

This manual contains the instructions that should be strictly observed at all times to prevent injury to yourself and other persons as well as damage to property.

Injuries and damage that might be caused by using the product improperly are classified according to the following symbols.

Pictorial indication	Description
 WARNING	Improper handling can cause serious injury or death.
 CAUTION	Improper handling can cause minor injury or damage to houses and property.

These are some of major exemplary graphical symbols

Graphic symbols	Descriptions	Graphic symbols	Descriptions	Graphic symbols	Descriptions
	General prohibition		Do not disassemble		Do not touch
	General instruction		Ground/Earth		Unplug from outlet
	General precaution		High temperature		Electrical shock hazard

Power source connection

 **WARNING**











Do not use any power cord other than the one supplied in the package or attached on the products. If a power cord is not supplied, use only the power cord and plug that are specified in the user documentation. Failure to use this cord could result in a fire or electrical shock. If the power cord supplied in the package cannot be used in the country where this product was sold, use a power cord that meets the following conditions or contact your Technical Representative.
 The power cord has voltage and current rating appropriate for the rating plate on this machine.
 The power cord meets regulatory requirements for the area.
 The power cord is provided with grounding pin/terminal.

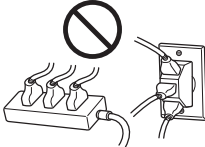
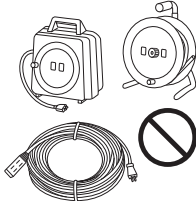

Do not use the power cord to other products. Failure to do that could result in a fire or electrical shock.



⚠ WARNING





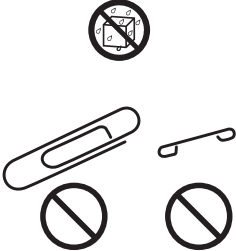
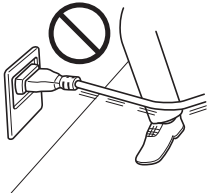

<p>Do not scratch, abrade, place a heavy object on, heat, twist, bend, step on, pull on, or damage the power cord. Use of a damaged power cord (exposed core wire, broken wire, etc.) could result in a fire or breakdown. Should any of these conditions be found, immediately turn OFF the power switch, unplug the power cord from the power outlet, and then call your authorized service representative.</p>	
<p>Do not use the power source voltage other than being specified on the machine. Failure to do that could result in a fire or electrical shock.</p>	
<p>Do not use a multiple outlet adapter to connect any other appliances or machines. Use of a power outlet for more than the marked current value could result in a fire or electrical shock.</p>	
<p>Do not use an extension cord. Use of an extension cord could cause a fire or electric shock. If the power cord furnished with the product is not long enough to be plugged into a wall outlet, contact your Technical Representative.</p>	
<p>Do not unplug and plug in the power cord with a wet hand, as an electrical shock could result.</p>	
<p>Plug the power cord all the way into the power outlet. Failure to do this could result in a fire or electrical shock.</p>	
<p>Make sure to ground this product. (Connect the power cord to an electrical outlet that is equipped with a grounding terminal.) Failure to do so and an unlikely event of leakage could result in a fire or electrical shock.</p>	
<p>⚠ CAUTION</p>	
<p>The outlet must be near the equipment and easily accessible. Otherwise you can not pull out the power plug when an emergency occurs.</p>	
<p>Do not place any objects around the power plug, as the power plug may be difficult to pull out when an emergency occurs.</p>	
<p>Do not tug the power cord when unplugging. Pulling on the power cord could damage the cord, resulting in a fire or electrical shock.</p>	
<p>Remove the power plug from the outlet more than one time a year and clean the area between the plug terminals. Dust that accumulates between the plug terminals may cause a fire.</p>	

Installation

WARNING













<p>Keep this bag away from babies and children. Do not use in cribs, beds, carriages, or playpens. The thin film may cling to nose and mouth and prevent breathing. This bag is not a toy.</p>	
<p>Do not place a flower vase or other container that contains water, or metal clips or other small metallic objects on this product. Spilled water or metallic objects dropped inside the product could result in a fire, electrical shock, or breakdown. Should a piece of metal, water, or any other similar foreign matter get inside the product, immediately turn OFF the power switch, unplug the power cord from the power outlet, and then call your Technical Representative or your authorized service representative.</p>	
<p>Make sure that the power cord is placed on a site in which no person would step on or trip over it. Stepping on or tripping over the power cord could heat the power cord, resulting in a fire or electric shock.</p>	

CAUTION

<p><If instructed to use fixing legs> When the product has been installed, fix the product using the fixing legs. Not using the fixing legs could cause the product to move or topple over.</p>	
<p>Do not place the product in a dusty place, or a site exposed to soot or steam, near a kitchen table, bath, or a humidifier. A fire, electrical shock, or breakdown could result.</p>	
<p>Do not place this product on an unstable or tilted bench, or in a location subject to a lot of vibration and shock. It could drop or fall, causing personal injury or mechanical breakdown.</p>	
<p>Do not let any object plug the ventilation holes of this product. Heat could accumulate inside the product, resulting in a fire or malfunction.</p>	
<p>Whenever moving this product, be sure to disconnect the power cord and other cables. Failure to do this could damage the cord or cable, resulting in a fire, electrical shock, or breakdown.</p>	
<p>When moving this product, always hold it at the locations specified in the User's Guide or other documents. If the unit is moved while held at locations other than those specified, it may fall, causing severe personal injury.</p>	

Using the product

WARNING

<p>Do not modify this product, as a fire, electrical shock, or breakdown could result. If the product employs a laser, the laser beam source could cause blindness.</p>	
<p>Do not attempt to remove the covers and panels which have been fixed to the product. Some products have a high-voltage part or a laser beam source inside that could cause an electrical shock or blindness.</p>	
<p>Do not keep using this product, if this product becomes inordinately hot or emits smoke, or unusual odor or noise. Immediately turn OFF the power switch, unplug the power cord from the power outlet, and then call your Technical Representative or your authorized service representative. If you keep on using it as is, a fire or electrical shock could result.</p>	
<p>Do not keep using this product, if this product has been dropped or its cover damaged. Immediately turn OFF the power switch, unplug the power cord from the power outlet, and then call your Technical Representative or your authorized service representative. If you keep on using it as is, a fire or electrical shock could result.</p>	
<p>Do not use flammable sprays, liquids, or gases inside or near this machine. Do not clean the inside of this machine using a flammable gas duster. A fire or explosion could result.</p>	
<p><If an RFID module (limited only to 13.56 MHz) for use in inside-the-machine proximity communication or electromagnetic induction heating (IH) technology (limited only to 20.05 kHz to 100 kHz) is being used> This machine generates a weak magnetic field. If you experience any unusual symptoms with your implantable medical equipment (cardiac pacemaker, etc.) while near the machine, move away from the machine and see a doctor immediately. Please call your Technical Representative or your authorized service representative if you do not understand the purchased product corresponds or not.</p>	
<p><If a non-contact IC card reader is being used> If you use an implantable medical equipment (cardiac pacemaker, etc.), do not bring the IC card reader close from the implant within 12 cm at all times. The radio waves may affect implantable medical equipment (cardiac pacemaker, etc.) operations.</p>	
<h3> CAUTION</h3>	
<p>Using this product in a poorly ventilated room for a long time or producing a large volume of copies or prints may cause the odor of exhaust air from the machine. Ventilate the room well.</p>	
<p>The inside of this product has areas subject to high temperature, which may cause burns. When checking the inside of the unit for malfunctions such as a paper misfeed, do not touch the locations (around the fusing unit, etc.) which are indicated by a "Caution HOT" caution label. A burn could result.</p>	 
<p>Unplug the product when you will not use the product for long periods of time.</p>	
<p>When using the machine, do not look at the light of the lamp for a prolonged time. Eyestrain could result.</p>	

⚠ CAUTION

Do not use stapled paper, conductive paper (such as silver paper or carbon paper) or treated heat-sensitive/inkjet paper, otherwise a fire may result.



Consumables

⚠ WARNING

Do not throw toner or a container that contains toner (e.g., toner cartridge, developing unit and Waste Toner Box) into an open flame. The hot toner may scatter and cause burns or other damage.



⚠ CAUTION

Do not leave toner-related parts (e.g., toner cartridge, developing unit and Waste Toner Box) within easy reach of children. Licking any of these parts or ingesting toner could damage your health.



Do not store toner-related parts (e.g., toner cartridge, developing unit and Waste Toner Box) near devices susceptible to magnetism, such as precision equipment and data storage devices, otherwise they may malfunction. They could cause these products to malfunction.



Do not force open the toner-related parts (e.g., toner cartridge, developing unit and Waste Toner Box). If toner tumbles from the toner bottle, take utmost care to avoid inhaling it or even getting skin contact.



If toner lands on your skin or clothing, wash thoroughly with soap and water.



If you inhale toner, move to a place with fresh air and gargle with a lot of water repeatedly. Should you get symptoms such as coughing, seek medical advice.



If you get toner into your eyes, immediately rinse them with running water for over 15 minutes. Seek medical advice if irritation persists.



If you swallow toner, rinse out your mouth and drink a few glasses of water. Seek medical advice if necessary.



Never touch the electrical contacts of the units (e.g., toner cartridge and developing unit), as an electrostatic discharge may damage the product.



Before handling, see the user documentation for the safety information.



<If instructed to replace the fusing unit>
The fusing section is extremely hot. Before replacing the fusing unit, be sure to open doors and covers of the machine. Then, leave the machine to stand idle for a specified period of time and make sure that the fusing section has cooled down to room temperature. Failure to follow these instructions could result in a burn.



1.3 Regulation notices

About certified model name

This product is certified by the following model name:
KONICA MINOLTA branded model bizhub 225i.

CE Marking (Declaration of Conformity) for users of the European Union (EU)

Hereby, Konica Minolta declares that the radio equipment models specified above are in compliance with Directive 2014/53/EU.

The full text of the EU declaration of conformity is available at the following internet address:
"<https://www.konicaminolta.eu/en/business-solutions/support/download-center.html>".

Choose your product and open the section "Safety Documents".

WARNING

- This device must be used with a shielded interface cable. The use of non-shielded cables is likely to result in interference with radio communications and is prohibited under EU directives.
-

GS Certification

This device is not intended for use in the direct field of view at visual display workplaces. To avoid incoming reflexions at visual display workplaces this device must not be placed in the direct field of view.

Das Gerät ist nicht für die Benutzung im unmittelbaren Gesichtsfeld am Bildschirmarbeitsplatz vorgesehen. Um störende Reflexionen am Bildschirmarbeitsplatz zu vermeiden, darf dieses Produkt nicht im unmittelbaren Gesichtsfeld platziert werden.

Laser safety

This is a digital machine which operates using a laser. There is no possibility of danger from the laser provided the machine is operated according to the instructions in the manuals.

Since radiation emitted by the laser is completely confined within protective housing, the laser beam cannot escape from the machine during any phase of user operation.

This machine is certified as a Class 1 laser product per IEC 60825-1: 2014: This means the machine does not produce hazardous laser radiation.

Internal laser radiation

Maximum Average Radiation Power: 6.9 μ W at the laser aperture of the print head unit.

Wavelength: 770-800 nm

This product employs a Class 3B laser diode that emits an invisible laser beam.

The laser diode and the scanning polygon mirror are incorporated in the print head unit.

The print head unit is NOT A FIELD SERVICE ITEM:

Therefore, the print head unit should not be opened under any circumstances.

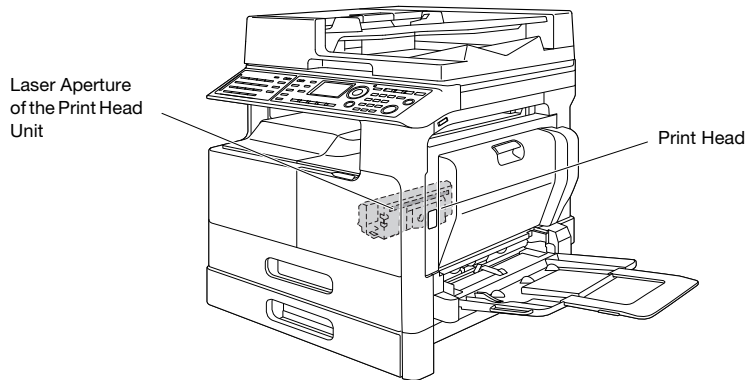

The laser opening can be found in the device with the drum unit removed.

CDRH regulations

This machine is certified as a Class 1 Laser product under Radiation Performance Standard according to the Food, Drug and Cosmetic Act of 1990. Compliance is mandatory for Laser products marketed in the United States and is reported to the Center for Devices and Radiological Health (CDRH) of the U.S. Food and Drug Administration of the U.S. Department of Health and Human Services (DHHS). This means that the device does not produce hazardous laser radiation.

The label shown on page 1-12 indicates compliance with the CDRH regulations and must be attached to laser products marketed in the United States.

⚠ WARNING

Use of controls, adjustments or performance of procedures other than those specified in this manual may result in hazardous radiation exposure.

- This is a semiconductor laser. The maximum power of the laser diode is 7 mW and the wavelength is 770-800 nm.
-

For European users

⚠ WARNING

Use of controls, adjustments or performance of procedures other than those specified in this manual may result in hazardous radiation exposure.

- This is a semiconductor laser. The maximum power of the laser diode is 7 mW and the wavelength is 770-800 nm.
-

Laser safety label

A laser safety label is attached to the outside of the machine, as shown below.

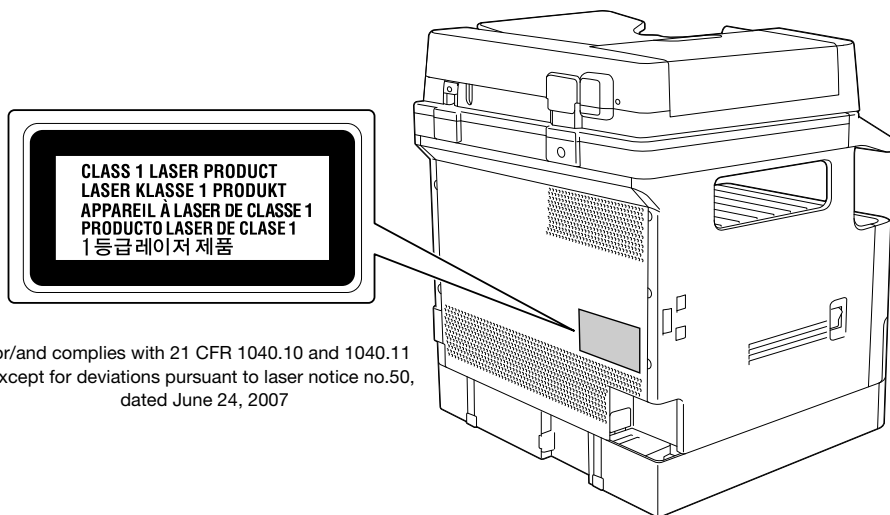

or/and complies with 21 CFR 1040.10 and 1040.11
except for deviations pursuant to laser notice no.50,
dated June 24, 2007

Ozone release

Locate the Machine in a Well-Ventilated Room

A negligible amount of ozone is generated during normal operation of this machine. An unpleasant odor may, however, be created in poorly ventilated rooms during extensive machine operations. For a comfortable, healthy and safe operating environment, it is recommended that the room be well ventilated.

Placer l'appareil dans une pièce largement ventilée

Une quantité d'ozone négligable est dégagée pendant le fonctionnement de l'appareil quand celui-ci est utilisé normalement. Cependant, une odeur désagréable peut être ressentie dans les pièces dont l'aération est insuffisante et lorsque une utilisation prolongée de l'appareil est effectuée. Pour avoir la certitude de travailler dans un environnement réunissant des conditions de confort, santé et de sécurité, il est préférable de bien aérer la pièce où se trouve l'appareil.

Acoustic noise (for German users only)

Der höchste Schalldruckpegel beträgt 70 dB(A) oder weniger gemäß EN ISO 7779.

For EU member states only

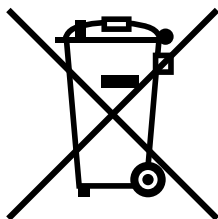

This symbol means: Do not dispose of this product together with your household waste!













Please refer to the information of your local community or contact our dealers regarding the proper handling of end-of-life electric and electronic equipments. Recycling of this product will help to conserve natural resources and prevent potential negative consequences for the environment and human health caused by inappropriate waste handling.



This product complies with RoHS (2011/65/EU) Directive.

Graphic symbols used on this machine

These are some of major exemplary graphical symbols.

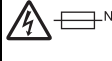
Graphic symbols	Descriptions	Graphic symbols	Descriptions	Graphic symbols	Descriptions
	"ON" position		"OFF" position		STAND-BY
	push-push type switches		Ground/Earth (Protective bonding terminal)		Ground/Earth (Protective earthing)
	CLASS II EQUIPMENT		Class II equipment with functional earthing		Functional earthing
	General precaution		High temperature		Electrical shock hazard
	CAUTION moving fan blade		CAUTION DOUBLE POLE / NEUTRAL FUSING		

1.6 Space requirements

To ensure that machine operation, consumables replenishing, part replacement, and regular maintenance can easily be performed, adhere to the recommended space requirements detailed below.

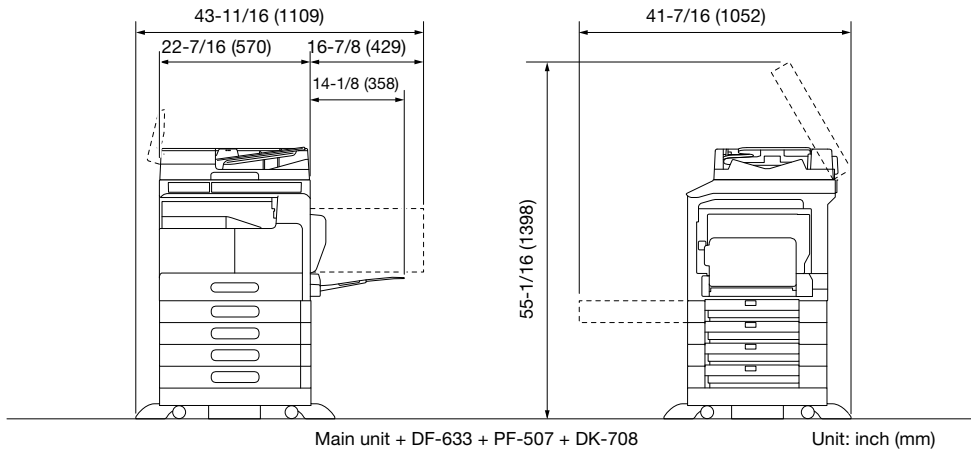
**NOTICE**

Be sure to allow a clearance of 7-7/8 inches (200 mm) or more at the back of this machine for the ventilation duct.

1.7 Operation precautions

To ensure the optimum performance of this machine, observe the precautions described below.

Power source

The power source requirements are as follows.

- Voltage fluctuation: Maximum $\pm 10\%$ (at AC 220 to 240 V)
- Frequency fluctuation: Maximum ± 3 Hz (at 50 Hz/60 Hz)
- Use a power source with as little voltage or frequency fluctuations as possible.

Operating environment

The environmental requirements for correct operation of the machine are as follows.

- Temperature: 10°C to 30°C with fluctuations of no more than 10°C within an hour
- Humidity: 15% to 85% with fluctuations of no more than 10% within an hour

Storage of copies

To store copies, follow the recommendation listed below.

- Copies that are to be kept for a long time should be kept where they are not exposed to light in order to prevent them from fading.
- Adhesive that contains solvent (e.g., spray glue) may dissolve the toner on copies.
- Color copies have a thicker layer of toner than normal black-and-white copies. Therefore, when a color copy is folded, the toner at the fold may peel off.

1.8 Legal restrictions on reproduction

Certain types of originals must never be reproduced with the purpose or intent to pass reproductions of such originals off as the originals.

The following is not a complete list, but is meant to be used as a guide to responsible reproduction.

<Financial Instruments>

- Personal checks
- Traveler's checks
- Money orders
- Certificates of deposit
- Bonds or other certificates of indebtedness
- Stock certificates

<Legal Originals>

- Food stamps
- Postage stamps (canceled or uncanceled)
- Checks or drafts drawn by government agencies
- Internal revenue stamps (canceled or uncanceled)
- Passports
- Immigration papers
- Motor vehicle licenses and titles
- House and property titles and deeds

<General>

- Identification cards, badges, or insignias
- Copyrighted works without permission of the copyright owner

In addition, it is prohibited under any circumstances to reproduce domestic or foreign currencies, or works of art without permission of the copyright owner.

When in doubt about the nature of an original, consult with legal counsel.

NOTICE

This machine provides the forgery prevention function in order to prevent financial instruments from being reproduced illegally.

We appreciate your understanding that printed images may infrequently have some noise or image data may not be stored under certain circumstances due to this forgery prevention function.

1.9 Trademarks and copyrights

KONICA MINOLTA, the KONICA MINOLTA logo, Giving Shape to Ideas, and bizhub are registered trademarks or trademarks of KONICA MINOLTA, INC.

Mozilla and Firefox are trademarks of the Mozilla Foundation.

Novell and Novell NetWare are registered trademarks of Novell, Inc. in the United States and other countries.

Microsoft, Windows, Windows 7, Windows 8.1, and Windows 10 are either registered trademarks or trademarks of Microsoft Corporation in the United States and/or other countries.

In regard to the Citrix Technology Member

KONICA MINOLTA INC. is a Citrix Technology Member

The Citrix Technology Member is a program that, in combination with a solution of Citrix, promotes and develops solutions in order to be an industry leader in providing customers with better solutions.

XenApp™, Citrix XenServer™ and Citrix Presentation Server™ are trademarks of Citrix®

Apple, Macintosh, Mac OS and Safari are registered trademarks of Apple Inc.

IOS is a trademark or registered trademark of Cisco in the U.S. and other countries and is used under license.

CUPS and CUPS logo are trademarks of Apple Inc.

Android is registered trademarks or trademarks of Google Inc.

Adobe, the Adobe logo, Acrobat are either registered trademarks or trademarks of Adobe Systems Incorporated in the United States and/or other countries.

Ethernet is a registered trademark of Xerox Corporation.

This product contains Adobe® Flash® Player under license from Adobe Systems Incorporated.

Copyright © 1995-2007 Adobe Macromedia Software LLC. All rights reserved.

Adobe and Flash are either registered trademarks or trademarks of Adobe Systems Incorporated in the United States and/or other countries.

OpenSSL License

LICENSE ISSUES

The OpenSSL toolkit stays under a double license, i.e. both the conditions of the OpenSSL License and the original SSLeay license apply to the toolkit.

See below for the actual license texts. Actually both licenses are BSD-style Open Source licenses. In case of any license issues related to OpenSSL please contact openssl-core@openssl.org.

OpenSSL License

Copyright © 1998-2017 The OpenSSL Project. All rights reserved.

Redistribution and use in source and binary forms, with or without modification, are permitted provided that the following conditions are met:

1. Redistributions of source code must retain the above copyright notice, this list of conditions and the following disclaimer.
2. Redistributions in binary form must reproduce the above copyright notice, this list of conditions and the following disclaimer in the documentation and/or other materials provided with the distribution.
3. All advertising materials mentioning features or use of this software must display the following acknowledgment:
"This product includes software developed by the OpenSSL Project for use in the OpenSSL Toolkit. (<http://www.openssl.org/>)"
4. The names "OpenSSL Toolkit" and "OpenSSL Project" must not be used to endorse or promote products derived from this software without prior written permission. For written permission, please contact openssl-core@openssl.org.
5. Products derived from this software may not be called "OpenSSL" nor may "OpenSSL" appear in their names without prior written permission of the OpenSSL Project.
6. Redistributions of any form whatsoever must retain the following acknowledgment:
"This product includes software developed by the OpenSSL Project for use in the OpenSSL Toolkit (<http://www.openssl.org/>)"

THIS SOFTWARE IS PROVIDED BY THE OpenSSL PROJECT "AS IS" AND ANY EXPRESSED OR IMPLIED WARRANTIES, INCLUDING, BUT NOT LIMITED TO, THE IMPLIED WARRANTIES OF MERCHANTABILITY AND FITNESS FOR A PARTICULAR PURPOSE ARE DISCLAIMED. IN NO EVENT SHALL THE OpenSSL PROJECT OR ITS CONTRIBUTORS BE LIABLE FOR ANY DIRECT, INDIRECT, INCIDENTAL, SPECIAL, EXEMPLARY, OR CONSEQUENTIAL DAMAGES (INCLUDING, BUT NOT LIMITED TO, PROCUREMENT OF SUBSTITUTE GOODS OR SERVICES; LOSS OF USE, DATA, OR PROFITS; OR BUSINESS INTERRUPTION) HOWEVER CAUSED AND ON ANY THEORY OF LIABILITY, WHETHER IN CONTRACT, STRICT LIABILITY, OR TORT (INCLUDING NEGLIGENCE OR OTHERWISE) ARISING IN ANY WAY OUT OF THE USE OF THIS SOFTWARE, EVEN IF ADVISED OF THE POSSIBILITY OF SUCH DAMAGE.

This product includes cryptographic software written by Eric Young (eay@cryptsoft.com). This product includes software written by Tim Hudson (tjh@cryptsoft.com).

Original SSLeay License

Copyright © 1995-1998 Eric Young (eay@cryptsoft.com) All rights reserved.

This package is an SSL implementation written by Eric Young (eay@cryptsoft.com).

The implementation was written so as to conform with Netscapes SSL.

This library is free for commercial and non-commercial use as long as the following conditions are adhered to. The following conditions apply to all code found in this distribution, be it the RC4, RSA, lhash, DES, etc., code; not just the SSL code.

The SSL documentation included with this distribution is covered by the same copyright terms except that the holder is Tim Hudson (tjh@cryptsoft.com).

Copyright remains Eric Young's, and as such any Copyright notices in the code are not to be removed. If this package is used in a product, Eric Young should be given attribution as the author of the parts of the library used. This can be in the form of a textual message at program startup or in documentation (online or textual) provided with the package.

Redistribution and use in source and binary forms, with or without modification, are permitted provided that the following conditions are met:

1. Redistributions of source code must retain the copyright notice, this list of conditions and the following disclaimer.
2. Redistributions in binary form must reproduce the above copyright notice, this list of conditions and the following disclaimer in the documentation and/or other materials provided with the distribution.
3. All advertising materials mentioning features or use of this software must display the following acknowledgement:
"This product includes cryptographic software written by Eric Young (eay@cryptsoft.com)"
The word 'cryptographic' can be left out if the routines from the library being used are not cryptographic related:-).
4. If you include any Windows specific code (or a derivative thereof) from the apps directory (application code) you must include an acknowledgement:
"This product includes software written by Tim Hudson (tjh@cryptsoft.com)"

THIS SOFTWARE IS PROVIDED BY ERIC YOUNG "AS IS" AND ANY EXPRESS OR IMPLIED WARRANTIES, INCLUDING, BUT NOT LIMITED TO, THE IMPLIED WARRANTIES OF MERCHANTABILITY AND FITNESS FOR A PARTICULAR PURPOSE ARE DISCLAIMED. IN NO EVENT SHALL THE AUTHOR OR CONTRIBUTORS BE LIABLE FOR ANY DIRECT, INDIRECT, INCIDENTAL, SPECIAL, EXEMPLARY, OR CONSEQUENTIAL DAMAGES (INCLUDING, BUT NOT LIMITED TO, PROCUREMENT OF SUBSTITUTE GOODS OR SERVICES; LOSS OF USE, DATA, OR PROFITS; OR BUSINESS INTERRUPTION) HOWEVER CAUSED AND ON ANY THEORY OF LIABILITY, WHETHER IN CONTRACT, STRICT LIABILITY, OR TORT (INCLUDING NEGLIGENCE OR OTHERWISE) ARISING IN ANY WAY OUT OF THE USE OF THIS SOFTWARE, EVEN IF ADVISED OF THE POSSIBILITY OF SUCH DAMAGE.

The licence and distribution terms for any publically available version or derivative of this code cannot be changed. i.e. this code cannot simply be copied and put under another distribution licence [including the GNU Public Licence.]

Kerberos

Copyright © 1985-2007 by the Massachusetts Institute of Technology.

All rights reserved.

Export of this software from the United States of America may require a specific license from the United States Government. It is the responsibility of any person or organization contemplating export to obtain such a license before exporting.

WITHIN THAT CONSTRAINT, permission to use, copy, modify, and distribute this software and its documentation for any purpose and without fee is hereby granted, provided that the above copyright notice appear in all copies and that both that copyright notice and this permission notice appear in supporting documentation, and that the name of M.I.T. not be used in advertising or publicity pertaining to distribution of the software without specific, written prior permission. Furthermore if you modify this software you must label your software as modified software and not distribute it in such a fashion that it might be confused with the original MIT software. M.I.T. makes no representations about the suitability of this software for any purpose. It is provided "as is" without express or implied warranty.

THIS SOFTWARE IS PROVIDED "AS IS" AND WITHOUT ANY EXPRESS OR IMPLIED WARRANTIES, INCLUDING, WITHOUT LIMITATION, THE IMPLIED WARRANTIES OF MERCHANTABILITY AND FITNESS FOR A PARTICULAR PURPOSE.

Individual source code files are copyright MIT, Cygnus Support, Novell, OpenVision Technologies, Oracle, Red Hat, Sun Microsystems, FundsXpress, and others.

Project Athena, Athena, Athena MUSE, Discuss, Hesiod, Kerberos, Moira, and Zephyr are trademarks of the Massachusetts Institute of Technology (MIT). No commercial use of these trademarks may be made without prior written permission of MIT.

"Commercial use" means use of a name in a product or other for-profit manner. It does NOT prevent a commercial firm from referring to the MIT trademarks in order to convey information (although in doing so, recognition of their trademark status should be given).

Portions of src/lib/crypto have the following copyright:

Copyright © 1998 by the FundsXpress, INC.

All rights reserved.

Export of this software from the United States of America may require a specific license from the United States Government. It is the responsibility of any person or organization contemplating export to obtain such a license before exporting.

WITHIN THAT CONSTRAINT, permission to use, copy, modify, and distribute this software and its documentation for any purpose and without fee is hereby granted, provided that the above copyright notice appear in all copies and that both that copyright notice and this permission notice appear in supporting documentation, and that the name of FundsXpress. not be used in advertising or publicity pertaining to distribution of the software without specific, written prior permission. FundsXpress makes no representations about the suitability of this software for any purpose. It is provided "as is" without express or implied warranty.

THIS SOFTWARE IS PROVIDED "AS IS" AND WITHOUT ANY EXPRESS OR IMPLIED WARRANTIES, INCLUDING, WITHOUT LIMITATION, THE IMPLIED WARRANTIES OF MERCHANTABILITY AND FITNESS FOR A PARTICULAR PURPOSE.

The implementation of the Yarrow pseudo-random number generator in src/lib/crypto/yarrow has the following copyright:

Copyright 2000 by Zero-Knowledge Systems, Inc.

Permission to use, copy, modify, distribute, and sell this software and its documentation for any purpose is hereby granted without fee, provided that the above copyright notice appear in all copies and that both that copyright notice and this permission notice appear in supporting documentation, and that the name of Zero-Knowledge Systems, Inc. not be used in advertising or publicity pertaining to distribution of the software without specific, written prior permission. Zero-Knowledge Systems, Inc. makes no representations about the suitability of this software for any purpose. It is provided "as is" without express or implied warranty.

ZERO-KNOWLEDGE SYSTEMS, INC. DISCLAIMS ALL WARRANTIES WITH REGARD TO THIS SOFTWARE, INCLUDING ALL IMPLIED WARRANTIES OF MERCHANTABILITY AND FITNESS, IN NO EVENT SHALL ZERO-KNOWLEDGE SYSTEMS, INC. BE LIABLE FOR ANY SPECIAL, INDIRECT OR CONSEQUENTIAL DAMAGES OR ANY DAMAGES WHATSOEVER RESULTING FROM LOSS OF USE, DATA OR PROFITS,

WHETHER IN AN ACTION OF CONTRACT, NEGLIGENCE OR OTHER TORTUOUS ACTION, ARISING OUT OF OR IN CONNECTION WITH THE USE OR PERFORMANCE OF THIS SOFTWARE.

The implementation of the AES encryption algorithm in src/lib/crypto/aes has the following copyright:

Copyright © 2001, Dr Brian Gladman <brg@gladman.uk.net>, Worcester, UK.

All rights reserved.

LICENSE TERMS

The free distribution and use of this software in both source and binary form is allowed (with or without changes) provided that:

1. distributions of this source code include the above copyright notice, this list of conditions and the following disclaimer;
2. distributions in binary form include the above copyright notice, this list of conditions and the following disclaimer in the documentation and/or other associated materials;
3. the copyright holder's name is not used to endorse products built using this software without specific written permission.

DISCLAIMER

This software is provided 'as is' with no explicit or implied warranties in respect of any properties, including, but not limited to, correctness and fitness for purpose.

Portions contributed by Red Hat, including the pre-authentication plug-ins framework, contain the following copyright:

Copyright © 2006 Red Hat, Inc.

Portions copyright © 2006 Massachusetts Institute of Technology

All Rights Reserved.

Redistribution and use in source and binary forms, with or without modification, are permitted provided that the following conditions are met:

- * Redistributions of source code must retain the above copyright notice, this list of conditions and the following disclaimer.
- * Redistributions in binary form must reproduce the above copyright notice, this list of conditions and the following disclaimer in the documentation and/or other materials provided with the distribution.
- * Neither the name of Red Hat, Inc., nor the names of its contributors may be used to endorse or promote products derived from this software without specific prior written permission.

THIS SOFTWARE IS PROVIDED BY THE COPYRIGHT HOLDERS AND CONTRIBUTORS "AS IS" AND ANY EXPRESS OR IMPLIED WARRANTIES, INCLUDING, BUT NOT LIMITED TO, THE IMPLIED WARRANTIES OF MERCHANTABILITY AND FITNESS FOR A PARTICULAR PURPOSE ARE DISCLAIMED. IN NO EVENT SHALL THE COPYRIGHT OWNER OR CONTRIBUTORS BE LIABLE FOR ANY DIRECT, INDIRECT, INCIDENTAL, SPECIAL, EXEMPLARY, OR CONSEQUENTIAL DAMAGES (INCLUDING, BUT NOT LIMITED TO, PROCUREMENT OF SUBSTITUTE GOODS OR SERVICES; LOSS OF USE, DATA, OR PROFITS; OR BUSINESS INTERRUPTION) HOWEVER CAUSED AND ON ANY THEORY OF LIABILITY, WHETHER IN CONTRACT, STRICT LIABILITY, OR TORT (INCLUDING NEGLIGENCE OR OTHERWISE) ARISING IN ANY WAY OUT OF THE USE OF THIS SOFTWARE, EVEN IF ADVISED OF THE POSSIBILITY OF SUCH DAMAGE.

Portions funded by Sandia National Laboratory and developed by the University of Michigan's Center for Information Technology Integration, including the PKINIT implementation, are subject to the following license:

COPYRIGHT © 2006-2007

THE REGENTS OF THE UNIVERSITY OF MICHIGAN

ALL RIGHTS RESERVED

Permission is granted to use, copy, create derivative works and redistribute this software and such derivative works for any purpose, so long as the name of The University of Michigan is not used in any advertising or publicity pertaining to the use of distribution of this software without specific, written prior authorization. If the above copyright notice or any other identification of the University of Michigan is included in any copy of any portion of this software, then the disclaimer below must also be included.

THIS SOFTWARE IS PROVIDED AS IS, WITHOUT REPRESENTATION FROM THE UNIVERSITY OF MICHIGAN AS TO ITS FITNESS FOR ANY PURPOSE, AND WITHOUT WARRANTY BY THE UNIVERSITY OF MICHIGAN OF ANY KIND, EITHER EXPRESS OR IMPLIED, INCLUDING WITHOUT LIMITATION THE IMPLIED WARRANTIES OF MERCHANTABILITY AND FITNESS FOR A PARTICULAR PURPOSE. THE REGENTS OF THE UNIVERSITY OF MICHIGAN SHALL NOT BE LIABLE FOR ANY DAMAGES, INCLUDING SPECIAL, INDIRECT, INCIDENTAL, OR CONSEQUENTIAL DAMAGES, WITH RESPECT TO ANY CLAIM ARISING OUT OF OR IN CONNECTION WITH THE USE OF THE SOFTWARE, EVEN IF IT HAS BEEN OR IS HEREAFTER ADVISED OF THE POSSIBILITY OF SUCH DAMAGES.

The pkcs11.h file included in the PKINIT code has the following license:

Copyright 2006 g10 Code GmbH

Copyright 2006 Andreas Jellinghaus

This file is free software; as a special exception the author gives unlimited permission to copy and/or distribute it, with or without modifications, as long as this notice is preserved.

This file is distributed in the hope that it will be useful, but WITHOUT ANY WARRANTY, to the extent permitted by law; without even the implied warranty of MERCHANTABILITY or FITNESS FOR A PARTICULAR PURPOSE.

OpenLDAP

Copyright 1998-2001 The OpenLDAP Foundation

All rights reserved.

Redistribution and use in source and binary forms, with or without modification, are permitted only as authorized by the OpenLDAP Public License. A copy of this license is available at <http://www.OpenLDAP.org/license.html> or in file LICENSE in the top-level directory of the distribution.

OpenLDAP is a registered trademark of the OpenLDAP Foundation.

Individual files and/or contributed packages may be copyright by other parties and subject to additional restrictions.

This work is derived from the University of Michigan LDAP v3.3 distribution. Information concerning this software is available at: <http://www.umich.edu/~dirsvcs/ldap/>

This work also contains materials derived from public sources.

Additional Information about OpenLDAP can be obtained at:

<http://www.openldap.org/>

or by sending e-mail to:

info@OpenLDAP.org

Portions Copyright © 1992-1996 Regents of the University of Michigan.

All rights reserved.

Redistribution and use in source and binary forms are permitted provided that this notice is preserved and that due credit is given to the University of Michigan at Ann Arbor. The name of the University may not be used to endorse or promote products derived from this software without specific prior written permission. This software is provided "as is" without express or implied warranty.

Cyrus SASL

CMU libsasl

Tim Martin

Rob Earhart

Rob Siemborski

Copyright © 2001 Carnegie Mellon University.

All rights reserved.

Redistribution and use in source and binary forms, with or without modification, are permitted provided that the following conditions are met:

1. Redistributions of source code must retain the above copyright notice, this list of conditions and the following disclaimer.
2. Redistributions in binary form must reproduce the above copyright notice, this list of conditions and the following disclaimer in the documentation and/or other materials provided with the distribution.
3. The name "Carnegie Mellon University" must not be used to endorse or promote products derived from this software without prior written permission. For permission or any other legal details, please contact Office of Technology Transfer
Carnegie Mellon University
5000 Forbes Avenue
Pittsburgh, PA 15213-3890
(412) 268-4387, fax: (412) 268-7395
tech-transfer@andrew.cmu.edu
4. Redistributions of any form whatsoever must retain the following acknowledgment:
"This product includes software developed by Computing Services at Carnegie Mellon University (<http://www.cmu.edu/computing/>)."

CARNEGIE MELLON UNIVERSITY DISCLAIMS ALL WARRANTIES WITH REGARD TO THIS SOFTWARE, INCLUDING ALL IMPLIED WARRANTIES OF MERCHANTABILITY AND FITNESS, IN NO EVENT SHALL CARNEGIE MELLON UNIVERSITY BE LIABLE FOR ANY SPECIAL, INDIRECT OR CONSEQUENTIAL DAMAGES OR ANY DAMAGES WHATSOEVER RESULTING FROM LOSS OF USE, DATA OR PROFITS, WHETHER IN AN ACTION OF CONTRACT, NEGLIGENCE OR OTHER TORTIOUS ACTION, ARISING OUT OF OR IN CONNECTION WITH THE USE OR PERFORMANCE OF THIS SOFTWARE.

Smbfs

Copyright © 2000, 2001 Boris Popov

All rights reserved.

Redistribution and use in source and binary forms, with or without modification, are permitted provided that the following conditions are met:

1. Redistributions of source code must retain the above copyright notice, this list of conditions and the following disclaimer.
2. Redistributions in binary form must reproduce the above copyright notice, this list of conditions and the following disclaimer in the documentation and/or other materials provided with the distribution.
3. All advertising materials mentioning features or use of this software must display the following acknowledgement:
This product includes software developed by Boris Popov.
4. Neither the name of the author nor the names of any co-contributors may be used to endorse or promote products derived from this software without specific prior written permission.

THIS SOFTWARE IS PROVIDED BY THE AUTHOR AND CONTRIBUTORS "AS IS" AND ANY EXPRESS OR IMPLIED WARRANTIES, INCLUDING, BUT NOT LIMITED TO, THE IMPLIED WARRANTIES OF MERCHANTABILITY AND FITNESS FOR A PARTICULAR PURPOSE ARE DISCLAIMED. IN NO EVENT SHALL THE AUTHOR OR CONTRIBUTORS BE LIABLE FOR ANY DIRECT, INDIRECT, INCIDENTAL, SPECIAL, EXEMPLARY, OR CONSEQUENTIAL DAMAGES (INCLUDING, BUT NOT LIMITED TO, PROCUREMENT OF SUBSTITUTE GOODS OR SERVICES; LOSS OF USE, DATA, OR PROFITS; OR BUSINESS INTERRUPTION) HOWEVER CAUSED AND ON ANY THEORY OF LIABILITY, WHETHER IN CONTRACT, STRICT LIABILITY,

OR TORT (INCLUDING NEGLIGENCE OR OTHERWISE) ARISING IN ANY WAY OUT OF THE USE OF THIS SOFTWARE, EVEN IF ADVISED OF THE POSSIBILITY OF SUCH DAMAGE.

DES part of SSLeay

Copyright © 1995-1996 Eric Young (eay@mincom.oz.au)

All rights reserved.

This file is part of an SSL implementation written by Eric Young (eay@mincom.oz.au).

The implementation was written so as to conform with Netscapes SSL specification. This library and applications are FREE FOR COMMERCIAL AND NON-COMMERCIAL USE as long as the following conditions are adhered to.

Copyright remains Eric Young's, and as such any Copyright notices in the code are not to be removed. If this code is used in a product, Eric Young should be given attribution as the author of the parts used. This can be in the form of a textual message at program startup or in documentation (online or textual) provided with the package.

Redistribution and use in source and binary forms, with or without modification, are permitted provided that the following conditions are met:

1. Redistributions of source code must retain the copyright notice, this list of conditions and the following disclaimer.
2. Redistributions in binary form must reproduce the above copyright notice, this list of conditions and the following disclaimer in the documentation and/or other materials provided with the distribution.
3. All advertising materials mentioning features or use of this software must display the following acknowledgement:
This product includes software developed by Eric Young (eay@mincom.oz.au)

THIS SOFTWARE IS PROVIDED BY ERIC YOUNG "AS IS" AND ANY EXPRESS OR IMPLIED WARRANTIES, INCLUDING, BUT NOT LIMITED TO, THE IMPLIED WARRANTIES OF MERCHANTABILITY AND FITNESS FOR A PARTICULAR PURPOSE ARE DISCLAIMED. IN NO EVENT SHALL THE AUTHOR OR CONTRIBUTORS BE LIABLE FOR ANY DIRECT, INDIRECT, INCIDENTAL, SPECIAL, EXEMPLARY, OR CONSEQUENTIAL DAMAGES (INCLUDING, BUT NOT LIMITED TO, PROCUREMENT OF SUBSTITUTE GOODS OR SERVICES; LOSS OF USE, DATA, OR PROFITS; OR BUSINESS INTERRUPTION) HOWEVER CAUSED AND ON ANY THEORY OF LIABILITY, WHETHER IN CONTRACT, STRICT LIABILITY, OR TORT (INCLUDING NEGLIGENCE OR OTHERWISE) ARISING IN ANY WAY OUT OF THE USE OF THIS SOFTWARE, EVEN IF ADVISED OF THE POSSIBILITY OF SUCH DAMAGE.

The licence and distribution terms for any publically available version or derivative of this code cannot be changed. i.e. this code cannot simply be copied and put under another distribution licence [including the GNU Public Licence.]

Wide DHCPv6

Copyright © 1998 and 1999 WIDE Project.

All rights reserved.

Redistribution and use in source and binary forms, with or without modification, are permitted provided that the following conditions are met:

1. Redistributions of source code must retain the above copyright notice, this list of conditions and the following disclaimer.
2. Redistributions in binary form must reproduce the above copyright notice, this list of conditions and the following disclaimer in the documentation and/or other materials provided with the distribution.
3. Neither the name of the project nor the names of its contributors may be used to endorse or promote products derived from this software without specific prior written permission.

THIS SOFTWARE IS PROVIDED BY THE PROJECT AND CONTRIBUTORS "AS IS" AND ANY EXPRESS OR IMPLIED WARRANTIES, INCLUDING, BUT NOT LIMITED TO, THE IMPLIED WARRANTIES OF MERCHANTABILITY AND FITNESS FOR A PARTICULAR PURPOSE ARE DISCLAIMED. IN NO EVENT SHALL THE PROJECT OR CONTRIBUTORS BE LIABLE FOR ANY DIRECT, INDIRECT, INCIDENTAL, SPECIAL, EXEMPLARY, OR CONSEQUENTIAL DAMAGES (INCLUDING, BUT NOT LIMITED TO, PROCUREMENT OF SUBSTITUTE GOODS OR SERVICES; LOSS OF USE, DATA, OR PROFITS; OR BUSINESS INTERRUPTION) HOWEVER CAUSED AND ON ANY THEORY OF LIABILITY, WHETHER IN CONTRACT, STRICT LIABILITY, OR TORT

(INCLUDING NEGLIGENCE OR OTHERWISE) ARISING IN ANY WAY OUT OF THE USE OF THIS SOFTWARE, EVEN IF ADVISED OF THE POSSIBILITY OF SUCH DAMAGE.

OpenSLP

Copyright © 2000 Caldera Systems, Inc

All rights reserved.

Redistribution and use in source and binary forms, with or without modification, are permitted provided that the following conditions are met:

Redistributions of source code must retain the above copyright notice, this list of conditions and the following disclaimer.

Redistributions in binary form must reproduce the above copyright notice, this list of conditions and the following disclaimer in the documentation and/or other materials provided with the distribution.

Neither the name of Caldera Systems nor the names of its contributors may be used to endorse or promote products derived from this software without specific prior written permission.

THIS SOFTWARE IS PROVIDED BY THE COPYRIGHT HOLDERS AND CONTRIBUTORS "AS IS" AND ANY EXPRESS OR IMPLIED WARRANTIES, INCLUDING, BUT NOT LIMITED TO, THE IMPLIED WARRANTIES OF MERCHANTABILITY AND FITNESS FOR A PARTICULAR PURPOSE ARE DISCLAIMED. IN NO EVENT SHALL THE CALDERA SYSTEMS OR CONTRIBUTORS BE LIABLE FOR ANY DIRECT, INDIRECT, INCIDENTAL, SPECIAL, EXEMPLARY, OR CONSEQUENTIAL DAMAGES (INCLUDING, BUT NOT LIMITED TO, PROCUREMENT OF SUBSTITUTE GOODS OR SERVICES; LOSS OF USE, DATA, OR PROFITS; OR BUSINESS INTERRUPTION) HOWEVER CAUSED AND ON ANY THEORY OF LIABILITY, WHETHER IN CONTRACT, STRICT LIABILITY, OR TORT (INCLUDING NEGLIGENCE OR OTHERWISE) ARISING IN ANY WAY OUT OF THE USE OF THIS SOFTWARE, EVEN IF ADVISED OF THE POSSIBILITY OF SUCH DAMAGE.

lwIP

Copyright © 2001, 2002 Swedish Institute of Computer Science.

All rights reserved.

Redistribution and use in source and binary forms, with or without modification, are permitted provided that the following conditions are met:

1. Redistributions of source code must retain the above copyright notice, this list of conditions and the following disclaimer.
2. Redistributions in binary form must reproduce the above copyright notice, this list of conditions and the following disclaimer in the documentation and/or other materials provided with the distribution.
3. The name of the author may not be used to endorse or promote products derived from this software without specific prior written permission.

THIS SOFTWARE IS PROVIDED BY THE AUTHOR "AS IS" AND ANY EXPRESS OR IMPLIED WARRANTIES, INCLUDING, BUT NOT LIMITED TO, THE IMPLIED WARRANTIES OF MERCHANTABILITY AND FITNESS FOR A PARTICULAR PURPOSE ARE DISCLAIMED. IN NO EVENT SHALL THE AUTHOR BE LIABLE FOR ANY DIRECT, INDIRECT, INCIDENTAL, SPECIAL, EXEMPLARY, OR CONSEQUENTIAL DAMAGES (INCLUDING, BUT NOT LIMITED TO, PROCUREMENT OF SUBSTITUTE GOODS OR SERVICES; LOSS OF USE, DATA, OR PROFITS; OR BUSINESS INTERRUPTION) HOWEVER CAUSED AND ON ANY THEORY OF LIABILITY, WHETHER IN CONTRACT, STRICT LIABILITY, OR TORT (INCLUDING NEGLIGENCE OR OTHERWISE) ARISING IN ANY WAY OUT OF THE USE OF THIS SOFTWARE, EVEN IF ADVISED OF THE POSSIBILITY OF SUCH DAMAGE.

This file is part of the lwIP TCP/IP stack.

Author: Adam Dunkels <adam@sics.se>

FatFs License

FatFs has being developped as a personal project of the author, ChaN. It is free from the code anyone else wrote at current release. Following code block shows a copy of the FatFs license document that heading the source files.

FatFs - Generic FAT Filesystem Module R0.13c

Copyright © 2018, ChaN, all right reserved.

FatFs module is an open source software. Redistribution and use of FatFs in source and binary forms, with or without modification, are permitted provided that the following condition is met:

1. Redistributions of source code must retain the above copyright notice, this condition and the following disclaimer.

This software is provided by the copyright holder and contributors "AS IS" and any warranties related to this software are DISCLAIMED. The copyright owner or contributors be NOT LIABLE for any damages caused by use of this software.

Therefore FatFs license is one of the BSD-style licenses but there is a significant feature. FatFs is mainly intended for embedded systems. In order to extend the usability for commercial products, the redistributions of FatFs in binary form, such as embedded code, binary library and any forms without source code, does not need to include about FatFs in the documentations. This is equivalent to the 1-clause BSD license. Of course FatFs is compatible with the most of open source software licenses including GNU GPL. When you redistribute the FatFs source code with any changes or create a fork, the license can also be changed to GNU GPL, BSD-style license or any open source software license that not conflict with FatFs license.

Copyright

KONICA MINOLTA, INC. maintains the copyright of the printer drivers.

© 2019 KONICA MINOLTA, INC. All Rights Reserved.

Note

User's Guide may not be reproduced in part or in full without permission.

KONICA MINOLTA INC. will not be held liable for any incidents caused by using this printing system or User's Guide.

Information included in User's Guide is subject to change without notice.

1.10 SOFTWARE LICENSE AGREEMENT

PLEASE READ CAREFULLY THE LICENSE AGREEMENT BELOW BEFORE DOWNLOADING, INSTALLING OR USING THE SOFTWARE. DOWNLOADING, INSTALLING OR USING THE SOFTWARE SHALL BE DEEMED YOUR LAWFUL ACCEPTANCE OF THE TERMS AND CONDITIONS BELOW. IF YOU DO NOT AGREE TO THEM, DO NOT DOWNLOAD, INSTALL, NOR USE THE SOFTWARE.

1. SOFTWARE

"Software" means this computer program (software), independent from its distribution channel, i.e. whether downloaded on royalty-free basis (which may include digitally encoded, machine readable, scalable outline font data as encoded in a special format) or obtained on DVD or any other physical data carrier, together with all codes, techniques, software tools, format, design, concepts, methods and ideas associated with the computer program and all documentation related thereto.

2. COPYRIGHT AND INTELLECTUAL PROPERTY RIGHTS

This is a license agreement and not an agreement for sale. Konica Minolta Business Solutions Europe GmbH ("Konica Minolta") owns, or has been licensed from other owners ("Konica Minolta Licensor"), copyrights and other intellectual property rights of the Software, and any and all rights and title to the Software and any copy made from it are retained by Konica Minolta or Konica Minolta Licensor. In no event, this Agreement shall be deemed to assign any copyright and/or any intellectual property rights of the Software from Konica Minolta or Konica Minolta Licensor to you. Except as stated in this Agreement, you are not granted any rights to patents, copyrights, trade names, trademarks (whether registered or unregistered), or any other rights, franchises or licenses in respect of the Software. The Software is protected by copyright laws and international treaty provisions.

3. LICENSE

Konica Minolta hereby grants to you, and you agree to accept a non-exclusive, non-transferable and limited license, and you may:

- (i) install and use the Software only on your computer(s) connected via inhouse network with a product for which this Software is designed;
- (ii) allow users of the computers described above to use the Software, provided that you assure that all such users comply with the terms of this Agreement;
- (iii) use the Software only for your own customary business or personal purpose;
- (iv) make one copy of the Software only for backup or installation purpose in the support of the normal and intended use of the Software;
- (v) transfer the Software to other party by transferring a copy of this Agreement and all documentation along with the Software, provided that (a) you must, at the same time, either transfer to such other party or destroy all your other copies of the Software, (b) such transfer of possession terminates your license from Konica Minolta, and (c) you must assure that such other party has agreed to accept and be bound by the terms and conditions of this Agreement. If such other party does not accept such terms and conditions then you shall not transfer any copy of the Software.

4. RESTRICTIONS

(1) You must not without the prior written consent of Konica Minolta:

- (i) use, copy, modify, merge or transfer copies of the Software except as provided herein;
- (ii) reverse engineer, reverse assemble, reverse compile or any other way analyze the Software except permitted by law;
- (iii) sublicense, rent, lease or distribute the Software or any copy thereof; or
- (iv) remove, use, or alter any trademark, logo, copyright or other proprietary notices, legends, symbols or labels in the Software.

(2) You agree that you will not export the Software in any form in violation of any applicable laws and regulations regarding export control of any country.

5. LIMITED WARRANTIES

The Software is provided to you "as is" without any warranties whatsoever. The express terms of this Agreement are in lieu of all other warranties, express or implied and Konica Minolta, its affiliate companies and Konica Minolta Licensor disclaim all warranties with regard to the Software, express or implied, including, without limitation, implied warranties of merchantability, fitness for a particular purpose and non-infringement of third party rights. The disclaimer of warranty hereunder does not affect your statutory rights. In case of the disclaimer is not allowed by applicable law, the disclaimer shall only apply to you to the maximum extent permitted by the law.

6. LIMITATION OF REMEDIES

In no event will Konica Minolta, its affiliate companies nor Konica Minolta Licensor be liable for any lost profits, lost data, or any other indirect, special, punitive, incidental or consequential damages that result from use or inability to use the Software, even if Konica Minolta, its affiliate companies, its authorized remarketers or Konica Minolta Licensor have been advised of the possibility of such damages or for any claim by you based on a third party claim.

7. **TERMINATION**
You may terminate this license at any time by destroying the Software and all your copies of it. This Agreement shall also terminate if you fail to comply with any terms hereof. Upon such termination, you must immediately destroy all copies of the Software in your possession.
8. **GOVERNING LAW**
This Agreement shall be governed by the laws of the country where the delivery is made to the original customer.
9. **SEVERABILITY**
In the event that any part or parts of this Agreement shall be held illegal or null and void by any court or administrative body of competent jurisdiction, such determination shall not affect the remaining parts of this Agreement and they shall remain in full force and effect as if such part or parts determined illegal or void had not been included.
10. **NOTICE TO US GOVERNMENT END USERS**
The Software is a "commercial item," as that term is defined at 48 C.F.R. 2.101 (October 1995), consisting of "commercial computer software" and "commercial computer software documentation," as such terms are used in 48 C.F.R. 12.212 (September 1995). Consistent with 48 C.F.R. 12.212 and 48 C.F.R. 227.7202-1 through 227.7202-4 (June 1995), all U.S. Government End Users shall acquire the Software with only those rights set forth herein.

YOU ACKNOWLEDGE THAT YOU HAVE READ THIS AGREEMENT, UNDERSTAND IT, AND AGREE TO BE BOUND BY ITS TERMS AND CONDITIONS. NEITHER PARTY SHALL BE BOUND BY ANY OTHER STATEMENTS OR REPRESENTATIONS THAT ARE INCONSISTENT WITH THE TERMS AND CONDITIONS OF THIS AGREEMENT. NO AMENDMENT TO THIS AGREEMENT IS EFFECTIVE UNLESS IN WRITING AND SIGNED BY DULY AUTHORIZED REPRESENTATIVES OF EACH PARTY.



About This Machine

2 About This Machine

2.1 About the User's Guide

The User's Guide for this product is composed of PDF manuals on the "User's Guide CD/DVD".

User's guides contained on the CD/DVD

[Quick Guide]

This manual describes operating procedures and the most frequently used functions to enable you to begin using this machine immediately.

[User's Guide Copy]

This manual describes details on copy mode operations and the settings of this machine.

- Specifications of originals and copy paper
- Copy function
- Maintaining this machine
- Troubleshooting

[User's Guide Fax]

This manual describes details on fax functions.

- G3 fax function
- Internetwork fax
- PC-FAX

[User's Guide Print]

This manual describes details on printer functions.

- Printer function
- Setting the printer driver
- Mobile Print

[User's Guide Scan]

This manual describes details on scan functions.

- Scan Function
- Setting the TWAIN/WIA scan driver
- Network scan (E-mail TX, FTP TX, and SMB TX)
- Scan to USB

[User's Guide Network Administrator]

This manual describes details on setting methods for each function using the network connection.

- Network settings
- Settings using **Web Connection**

[Trademarks/Copyrights]

This manual describes details on trademarks and copyrights.

- Trademarks and copyrights

2.2 Functions of this machine

The **bizhub 225i** is a digital monochrome MFP that makes your workflow more efficient in any application or office environment. This MFP provides copy, fax, scanner, and printer functions that are critical to business operations, and it also has a network function that aids in efficient document management.

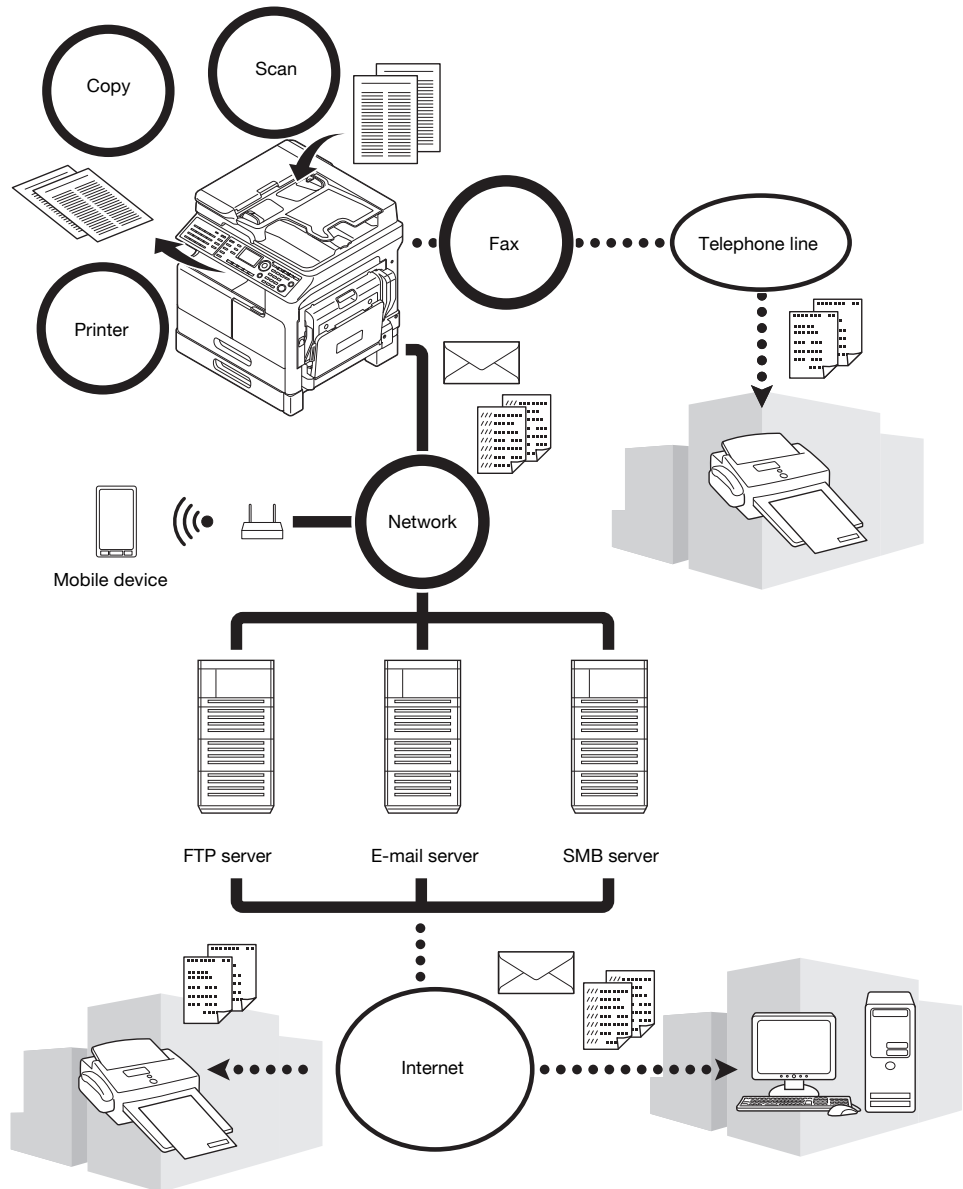

Copy function

This function outputs copies containing high-quality images at high speed. Furthermore, a variety of functions enable you to reduce costs and improve efficiency in your office.

Printer function

This function allows you to freely print data from a computer via the USB interface or network as a shared printer. When printing data, you can configure various settings such as the paper size, image quality, and layout. The printer driver can be installed easily from the CD/DVD-ROM supplied with this machine.

Fax function

This function sends the original scanned by this machine to a destination. You can send an original as an E-mail attachment using the Internet fax transmission function. You can also send it to multiple destinations at one time or forward received faxes.

By installing the fax driver, you can directly send a fax from a computer. To use the fax function, optional **FAX Kit FK-510** and **Extended Operation Panel MK-750** are required.

Network function

This function allows you to use this machine as a shared printer or to easily send data scanned by this machine to a destination via the network. You can use the **Control Panel** to send data to the FTP server, SMB server, or send it as an E-mail attachment.

Scan function

This function quickly converts paper documents into color digital data. You can easily send the converted data via a network. This machine can be used as a scanner with various application software products that are compatible with the TWAIN interface.

2.3 Control Panel

Name and function of each component of the Control Panel

The **Control Panel** has a **Display** area that displays messages and hardware keys such as the **Start** key and the **Clear/Stop** key. This section describes the functions of these keys.

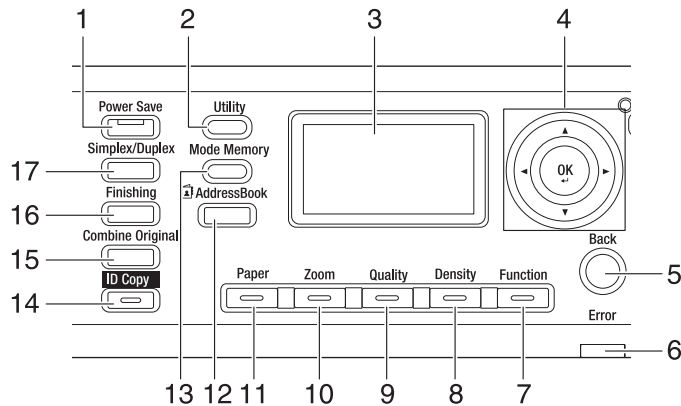

No.	Name	Function
1	Power Save	Press this key to switch to sleep mode.
2	Utility	In the Utility screen, you can configure the following settings: Machine setting, paper source setup, custom size memory, drum dehumidify, admin. management, copy setting 1, copy setting 2, dial registration, fax registration, fax tx operation, fax rx operation, reporting, scan setting, confirm mode.
3	Display	Displays the number of copies, zoom ratio, Utility screen, icons, and error messages.
4	▲, ▼, ◀, ▶ OK	Use the ▲, ▼, ◀, and ▶ key to move an option item in the Display or to change settings. Press the OK key to determine settings.
5	Back	Press this key to return to the previous screen.
6	Error	This lamp lights up or flashes when an error occurs.
7	Function	Press this key to configure the following advanced copy settings in the copy function screen: BOOK SEP., ERASE, OUTER ERASE, NEG. <-->POS., PAGE MARGIN, STAMP, MIXEDORIGINAL, X/Y ZOOM
8	Density	Press this key to specify the density with which to scan the original to be copied.
9	Quality	Press this key to select the image quality of the original from [TEXT], [PHOTO], and [TEXT/PHOTO].
10	Zoom	Press this key to enlarge or reduce an image in copy mode.
11	Paper	Press this key to select a paper tray to be used.
12	AddressBook	Press this key to display the information registered in the One-touch Dial, group dial, and speed dial.
13	Mode Memory	Press this key to register or recall the configured copy function.
14	ID Copy	Press this key to copy the contents of the front and back sides of a card-size original such as a driver's license, onto one sheet.
15	Combine Original	Press this key to copy a multi-page original onto one sheet.
16	Finishing	Press this key to select the copy finishing mode.
17	Simplex/Duplex	Press this key to use the 1-sided or 2-sided printing function.

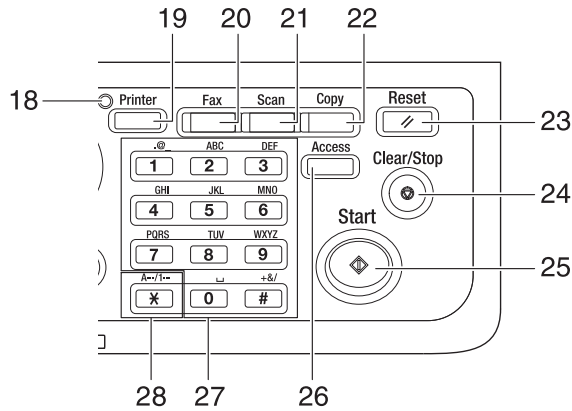

No.	Name	Function
18	Printer Indicator	This indicator lights up green when the machine is in printer mode.
19	Printer	Press this key to use the printer mode.
20	Fax	Press this key to switch to fax mode. The lamp lights up green to indicate that the machine is in fax mode.
21	Scan	Press this key to switch to scan mode. The lamp lights up green to indicate that the machine is in scan mode.
22	Copy	Press this key to switch to copy mode. The lamp lights up green to indicate that the machine is in copy mode.
23	Reset	<ul style="list-style-type: none"> Press this key to reset all settings you entered on the Control Panel. (Excluding the registered settings) Press this key to erase the jobs you are currently configuring.
24	Clear/Stop	<ul style="list-style-type: none"> Press this key to clear the digit your are currently entering. Press this key to stop continuous copy operations. Press this key to stop PC printing.
25	Start	<ul style="list-style-type: none"> Press this key to start a copy operation. Pressing this key while the machine is warming up starts the Next Copy Job function. This key lights up blue when the machine is ready to accept a copy job, and lights up orange when the machine is not ready to start a copy operation.
26	Access	Press this key to use account track.
27	Keypad	<ul style="list-style-type: none"> Specify the number of copies. Enter various settings.
28	A.../1...	Press this key to switch between numerals and letters you enter from the Keypad .

Extended Operation Panel MK-750 (Option)

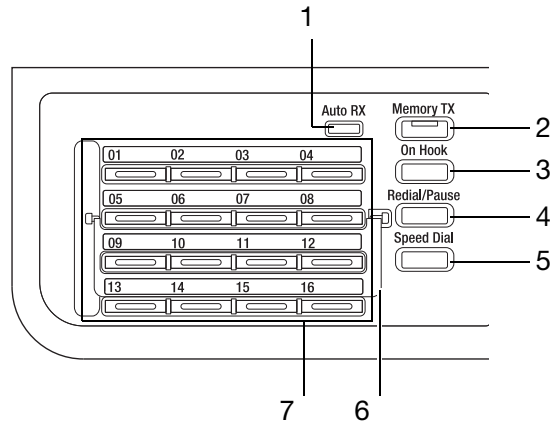

No.	Name	Function
1	Auto RX Indicator	This indicator lights up green when the machine is set in Auto RX mode.
2	Memory TX	Press this key to configure a Memory TX. This lamp lights up green when the Memory TX mode is set to ON.
3	On Hook	Press this key to set the machine in the state where the phone can be taken off the hook. Repressing this key returns the machine to the state where the phone can be hung up.
4	Redial/Pause	<ul style="list-style-type: none"> Press this key to redial the last recipient you called. This function is available in the wait time to make a call from an extension line to an external line, or to receive information from an information service.
5	Speed Dial	Press this key to dial a fax number pre-registered in the speed dial.
6	Switching Plate	Use this plate to switch the One-Touch Dial Key numbers. When the Switching Plate is closed downward, One-touch Dial keys 01 to 16 are available. When it is opened upward, One-touch Dial keys 17 to 32 are available.
7	One-Touch Dial Key	<ul style="list-style-type: none"> Press this key to dial a pre-registered destination. Use keys 01 to 32 to configure One-Touch Dial Key and group dial settings. Use keys 29 to 32 to configure program dial settings.

2.4 Operations on the Control Panel

When changing a setting, use the ▲, ▼, ◀, and ▶ key on this machine to move the cursor. To determine the setting you have selected, press the **OK** key.

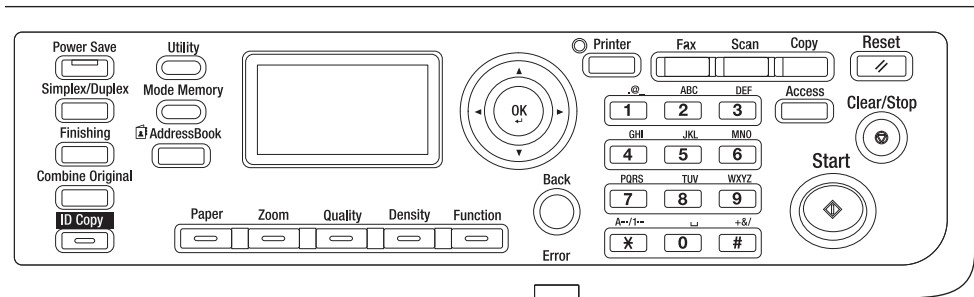

Specifying the zoom ratio

The following describes operations on the **Control Panel**, using the procedure for specifying the zoom ratio as an example.

- 1 Press the **Zoom** key.

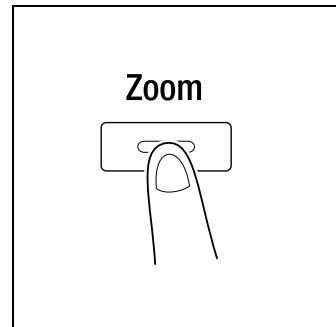

- 2 Press the ▼ key once, then press the **OK** key.

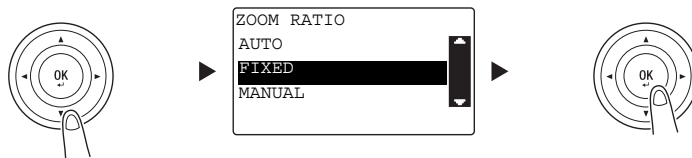

- 3 Press the ▼ key twice, then press the **OK** key.

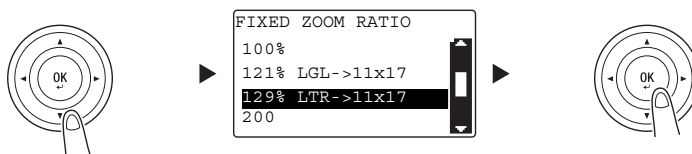

The zoom ratio has been specified.

Tips

In this document, the procedure described above is written as "Use the ▲/▼ key to select, then press the **OK** key". To correct the action you have carried out, press the **Back** key to return to the previous screen.

2.5 Turning the power on/off

Turning on the power

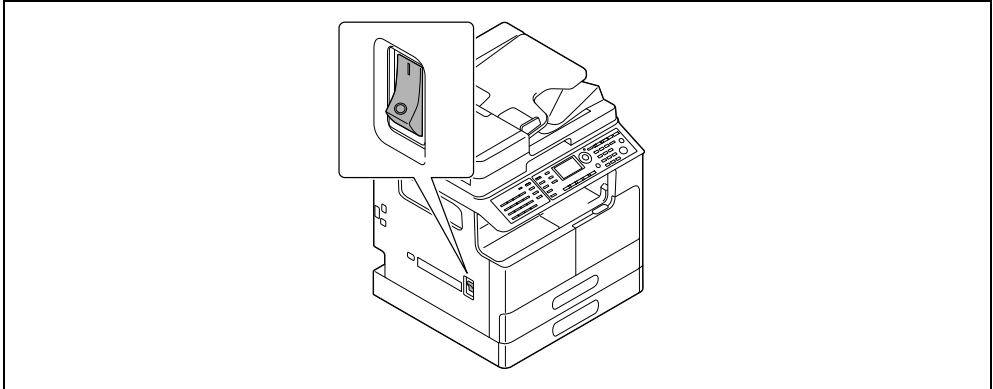

Turning off the power

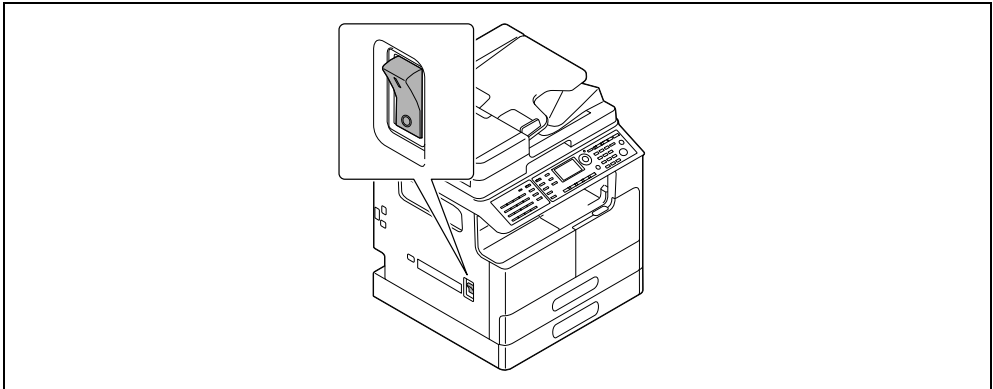

Tips

- In sleep mode, **Power Save** lights up green and the **Display** on the **Control Panel** turns off. This machine exits sleep mode when you press any key on the **Control Panel**. You do not need to turn the power off and on.
- Do not turn off the power when using the fax function. Otherwise, fax reception fails.
- Do not turn off the power during printing. Otherwise, a paper jam may occur.
- If you turn off the power while this machine is operating, the data being scanned, transmitted, or received, and jobs waiting to be performed, are deleted.

Reference

For details on turning the power on/off, refer to Chapter 2 of the [User's Guide Copy].

2.6 Original Set

You can load originals into this machine by placing them sheet by sheet onto the **Original Glass** or by putting multiple sheets into the **ADF**.

Loading the original onto the Original Glass

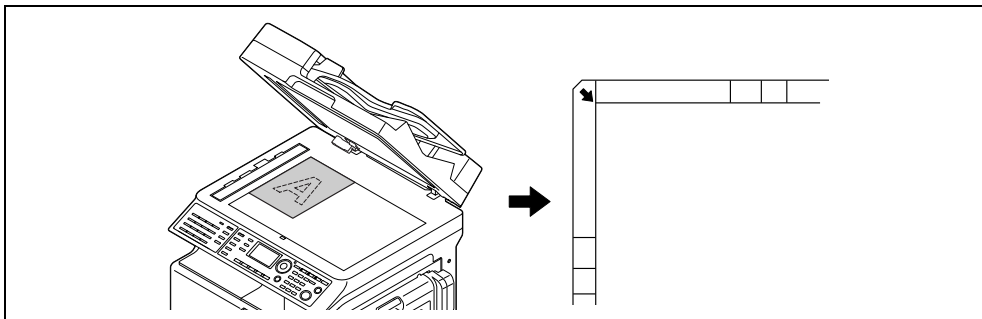

- 1** Open the **ADF** and load the original on it.
 - Load the original with the side you want to copy facing down.
 - Load the original along the **Original Scales** on the left and at the top of the **Original Glass**.
 - When loading a transparent original (such as OHP transparencies) or a thin original (tracing paper), place white paper on the original.
 - For sizes of originals that can be loaded onto the **Original Glass**, refer to Chapter 3 of the [User's Guide Copy].

- 2** Gently close the **ADF**.

You can also load a book original onto the **Original Glass**.

For details on the procedure, refer to Chapter 3 of the [User's Guide Copy].

Loading the original into the ADF

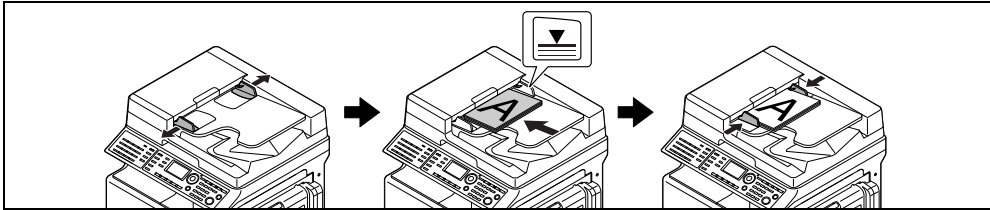

- 1 Open the **Lateral Guide** and load the original.
 - Load the original with the side you want to copy facing up.
 - For sizes of originals that can be loaded into the **ADF**, refer to Chapter 3 of the [User's Guide Copy].

NOTICE

*Do not load more than 130 sheets (21-1/4 lb (80 g/m²)) at a time into the Original Tray of the **ADF**, and do not load the sheets up to the point where the top of the stack is higher than the ▼ mark. Doing so may cause an original paper jam, original damage, or **ADF** failure. However, if the original contains more than 130 sheets (21-1/4 lb (80 g/m²)), it can be scanned separately.*

- 2 Adjust the **Lateral Guide** to the original size.
 - If the original is not loaded correctly, it may not be fed in straight.
 - You can also load mixed originals into the **ADF**. For details on the procedure, refer to Chapter 3 of the [User's Guide Copy].



Reference

If the orientation in which the original is loaded differs from the orientation in which paper is loaded into the paper tray, specify the original direction (orientation of loading the original). Otherwise, part of the images on the original may not be printed. For details on the orientation of the original, refer to Chapter 4 of the [User's Guide Copy].

2.7 Loading paper

Loading paper into Tray 1

- 1 Pull out **Tray 1**.
 - Press the lifter plate down until it "clicks" into position.

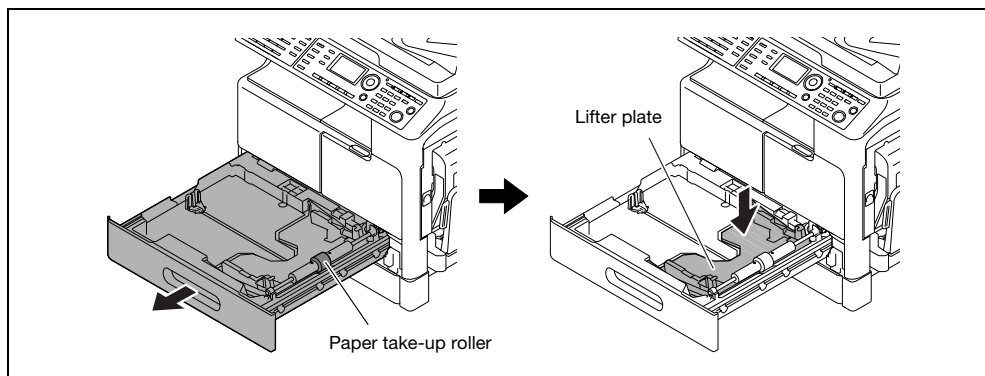

NOTICE

Be careful not to touch the surface of the paper take-up roller with your hand.

- 2 Slide the lateral guide to fit to the groove according to the paper size.
- 3 Set the paper and slide the lateral guide to fit to the paper edge.

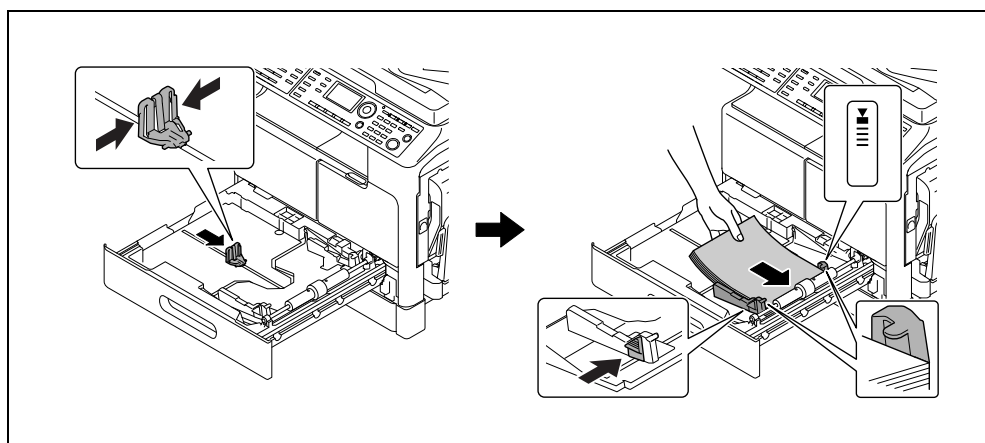

- Load the paper so that the side on which you want to print is facing up.
- For how to set custom sized paper, refer to page 3-7.
- Up to 250 sheets of plain paper can be loaded.
- Up to 20 sheets of thick paper can be loaded.
- Up to 10 OHP transparencies can be loaded.
- Up to 10 envelopes can be loaded.

NOTICE

*Do not load an excessive number of sheets such that the top of the stack is higher than the ▼ mark.
If paper is curled, flatten it before loading it.*

Reference

For details on how to load paper into Tray 1, refer to Chapter 3 of the [User's Guide Copy].

Loading paper into Tray 2, Tray 3, Tray 4, or Tray 5 (optional)

- 1 Pull out the tray.
 - Press the lifter plate down until it "clicks" into position.

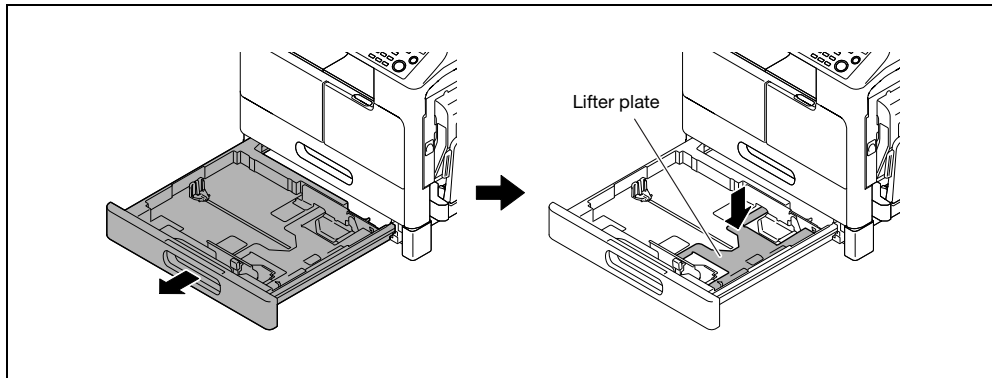

- 2 Slide the lateral guide to fit to the groove according to the paper size.
- 3 Set the paper and slide the lateral guide to fit to the paper edge.

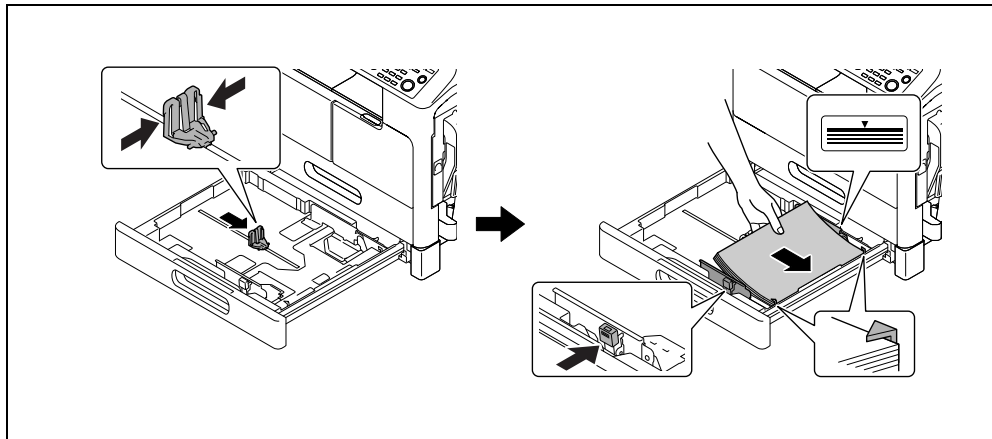

- Load the paper so that the side on which you want to print is facing up.
- Up to 250 sheets of plain paper can be loaded.
- Special paper (thick paper, OHP transparencies, or envelopes) cannot be loaded.

NOTICE

Do not load an excessive number of sheets such that the top of the stack is higher than the ▼ mark.

If paper is curled, flatten it before loading it.

Reference

For details on how to load paper into **Tray 2, Tray 3, Tray 4, or Tray 5**, refer to Chapter 3 of the [User's Guide Copy].

Loading paper into the Bypass Tray

You can load plain paper, OHP transparencies, envelopes, or other paper in the **Bypass Tray**. The following describes the procedure for loading plain paper into the **Bypass Tray**.

Tips

If you load paper other than plain paper, you must specify the paper type on the **Control Panel**.

- 1 Load the paper and adjust the lateral guide.

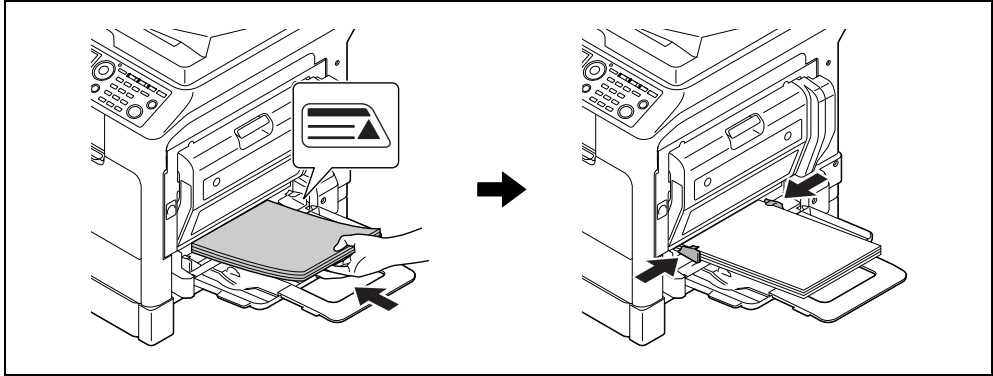

- Load the paper so that the side to be used for copying is facing down.
- Be sure that all paper is flat before loading it.
- Slide the guide to the size of the paper.
- Up to 100 sheets of plain paper can be loaded.
- Up to 20 sheets of thick paper can be loaded.
- Up to 10 OHP transparencies can be loaded.
- Up to 10 envelopes can be loaded.

NOTICE

Do not load an excessive number of sheets such that the top of the stack is higher than the ▼ mark.
If paper is curled, flatten it before loading it.

- 2 On the **Control Panel**, specify the paper.

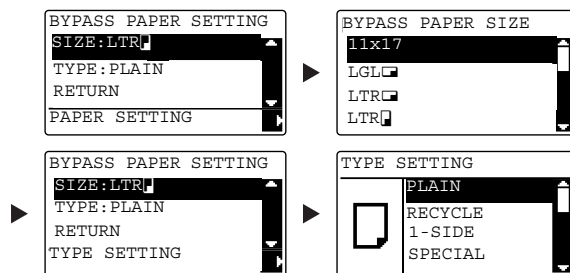

- Use the ▲/▼ key to select [SIZE], then press the ► key.
- Use the ▲/▼ key to select the paper size, then press the OK key.
- Use the ▲/▼ key to select [TYPE], then press the ► key.
- Use the ▲/▼ key to select the paper type, then press the OK key.

Reference

For details on how to load paper into the **Bypass Tray**, refer to Chapter 4 of the [User's Guide Copy].

2.8 Removing a jam

If a paper jam occurs in this machine, **Error** on the **Control Panel** lights up and a message appears. Be sure to see the **Display** to check the location of the jam before removing the jam.

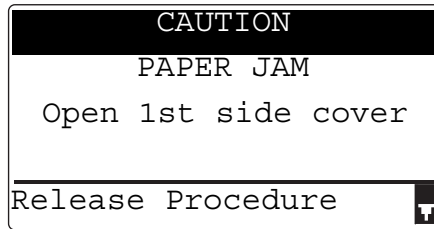

A message indicating the location of the jam appears in the **Display**.

Message		Location of the jam
[PAPER JAM]	[Open 1st side cover]	<ul style="list-style-type: none"> • Inside the main unit • Bypass Tray • Tray 1
	[Open 2nd side cover]	Tray 2
	[Open 3rd side cover]	Tray 3
	[Open 4th side cover]	Tray 4
	[Open 5th side cover]	Tray 5
	[Open duplex cover]	Automatic Duplex Unit
[Original doc. jam]	[Open doc. feed cover]	ADF

Press the ▼ key to confirm the paper jam procedure on the Display.

Removing a paper jam in the main unit, Bypass Tray, or Tray 1

The following describes the procedure for removing a paper jam in the main unit, **Bypass Tray**, or **Tray 1**.

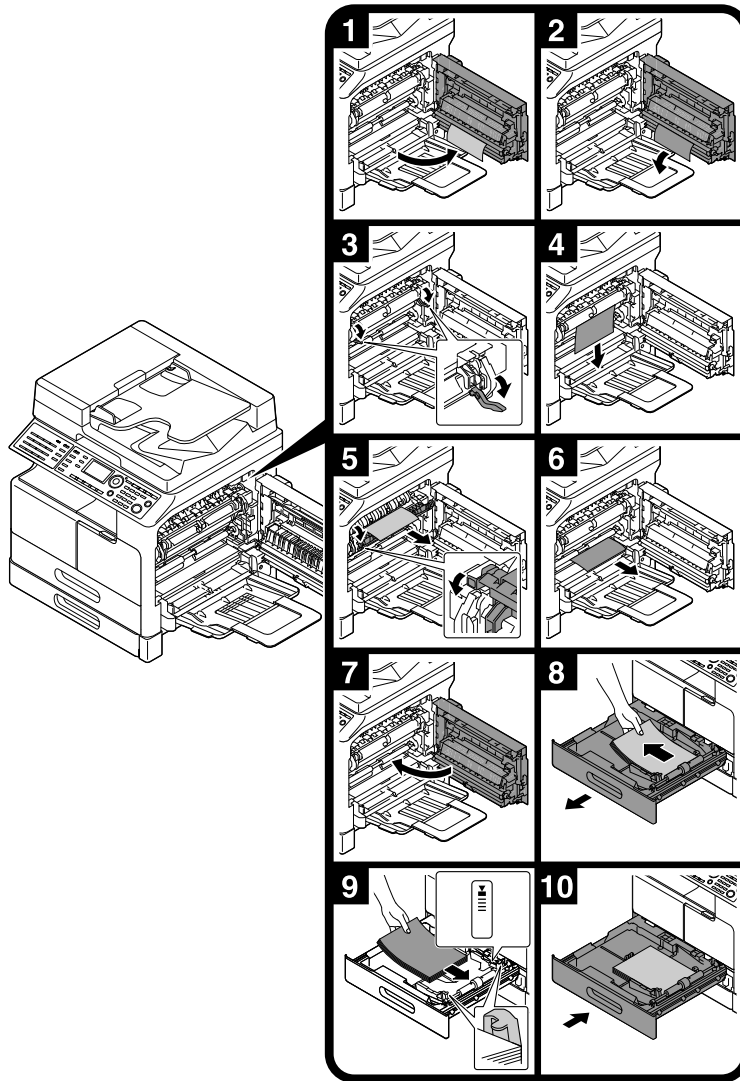

Tips

- Areas around the fusing unit are hot. To prevent burns, do not touch any parts other than those specified in the procedure. If you touch a hot component, immediately cool the skin with cool water and consult a physician.
- Touching the surface of the transfer roller can deteriorate the image quality of copies. Be careful not to touch the surface of the transfer roller with your hand.
- When releasing the pressure-bonding lever, hold the green part of the lever.
- Touching the surface of the PC drum can deteriorate the image quality of copies. Be careful not to touch the surface of the PC drum with your hand.

CAUTION

- The inside of this product has areas subject to high temperature, which may cause burns. When checking the inside of the unit for malfunctions such as a paper misfeed, do not touch the locations (around the fusing unit, etc.) which are indicated by a "Caution HOT" caution label. A burn could result.

Removing a paper jam in Tray 2, Tray 3, Tray 4, or Tray 5

The following describes the procedure for removing a paper jam from **Tray 2**, **Tray 3**, **Tray 4**, or **Tray 5**. **Tray 2** is used according to the following explanation. For **Tray 3**, **Tray 4**, and **Tray 5**, use the same procedure.

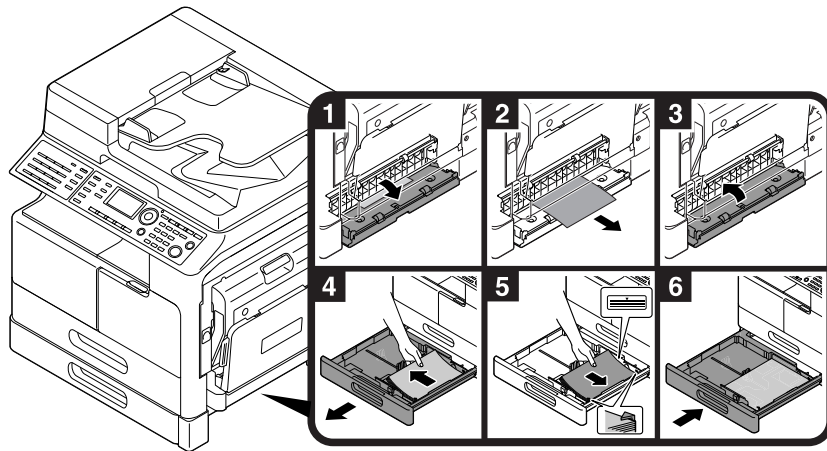

Removing a paper jam in the ADF

The following describes the procedure for removing a paper jam in the **ADF**.

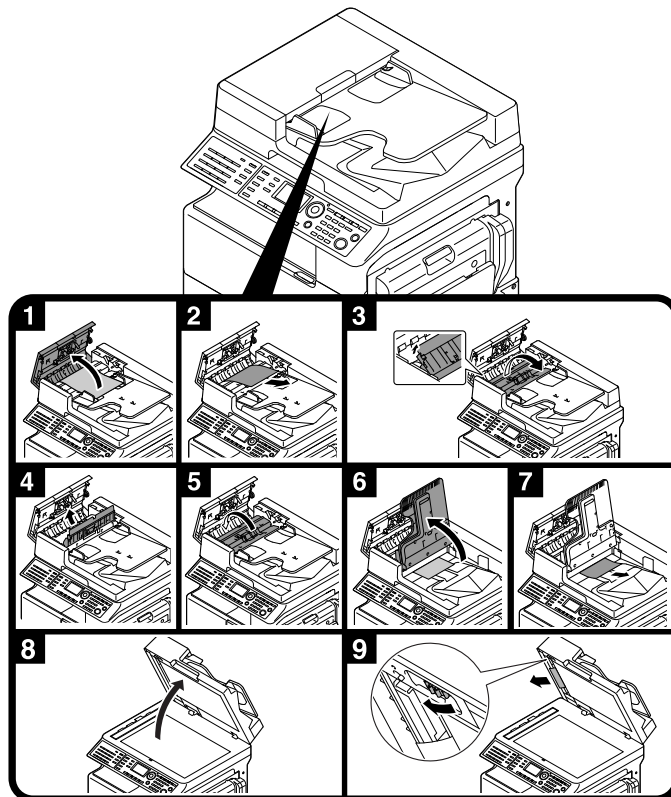

Removing a jam in the Automatic Duplex Unit

The following describes the procedure for removing a paper jam in the **Automatic Duplex Unit**.

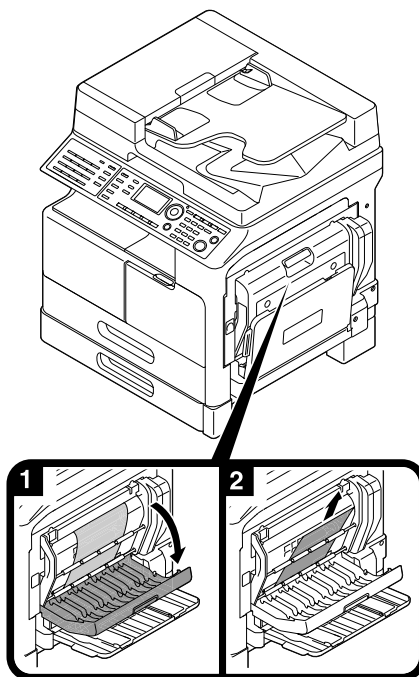

2.9 Replacing consumables

Replacing the Toner Bottle

When toner becomes exhausted, **Error** on the **Control Panel** lights up and a message appears. When the message appears, replace the **Toner Bottle** with a new one.

Press the ▼ key to confirm the toner replacement procedure on the Display.

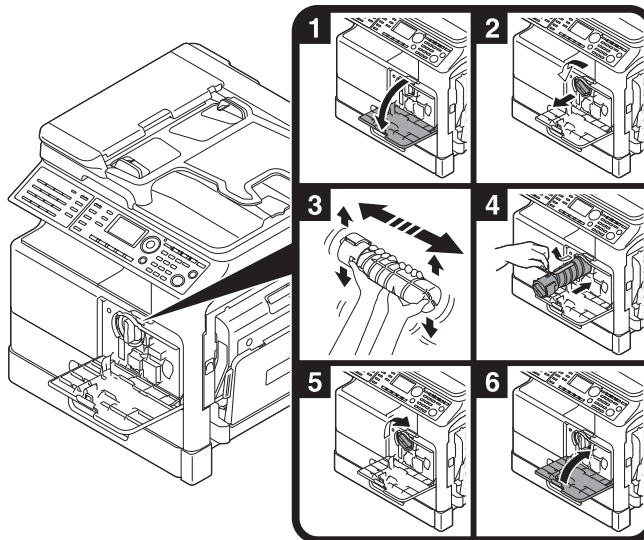
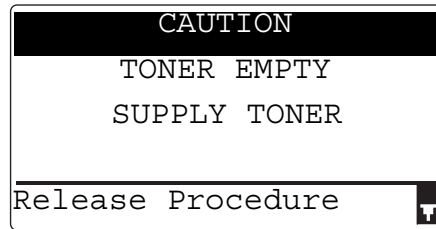

Tips

- For **Toner Bottle**, be sure to use a **Toner Bottle** dedicated for this machine. Use of another **Toner Bottle** will result in a failure. For details, contact your service representative.
- Your service representative collects empty **Toner Bottle**. Store empty toner bottles in the individual packaging box. Do not dispose of the bottles.
- Before installing a new **Toner Bottle**, give it a good shake approximately 5 to 10 times from side to side and up and down.
- Do not forcibly open or disassemble a **Toner Bottle** (toner container).
- Do not forcibly remove or dispose of toner that remains in a **Toner Bottle** (toner container).

⚠ WARNING

- Do not throw toner or a container that contains toner (e.g., toner cartridge, developing unit and Waste Toner Box) into an open flame. The hot toner may scatter and cause burns or other damage.

⚠ CAUTION

- Do not leave toner-related parts (e.g., toner cartridge, developing unit and Waste Toner Box) within easy reach of children. Licking any of these parts or ingesting toner could damage your health.
 - Do not store toner-related parts (e.g., toner cartridge, developing unit and Waste Toner Box) near devices susceptible to magnetism, such as precision equipment and data storage devices, otherwise they may malfunction. They could cause these products to malfunction.
 - Do not force open the toner-related parts (e.g., toner cartridge, developing unit and Waste Toner Box). If toner tumbles from the toner bottle, take utmost care to avoid inhaling it or even getting skin contact.
 - If toner lands on your skin or clothing, wash thoroughly with soap and water.
 - If you inhale toner, move to a place with fresh air and gargle with a lot of water repeatedly. Should you get symptoms such as coughing, seek medical advice.
 - If you get toner into your eyes, immediately rinse them with running water for over 15 minutes. Seek medical advice if irritation persists.
 - If you swallow toner, rinse out your mouth and drink a few glasses of water. Seek medical advice if necessary.
-

2.10 Option configuration

This section describes the options that can be installed on this machine.

By adding options, you will be able to meet the various requirements of your office.

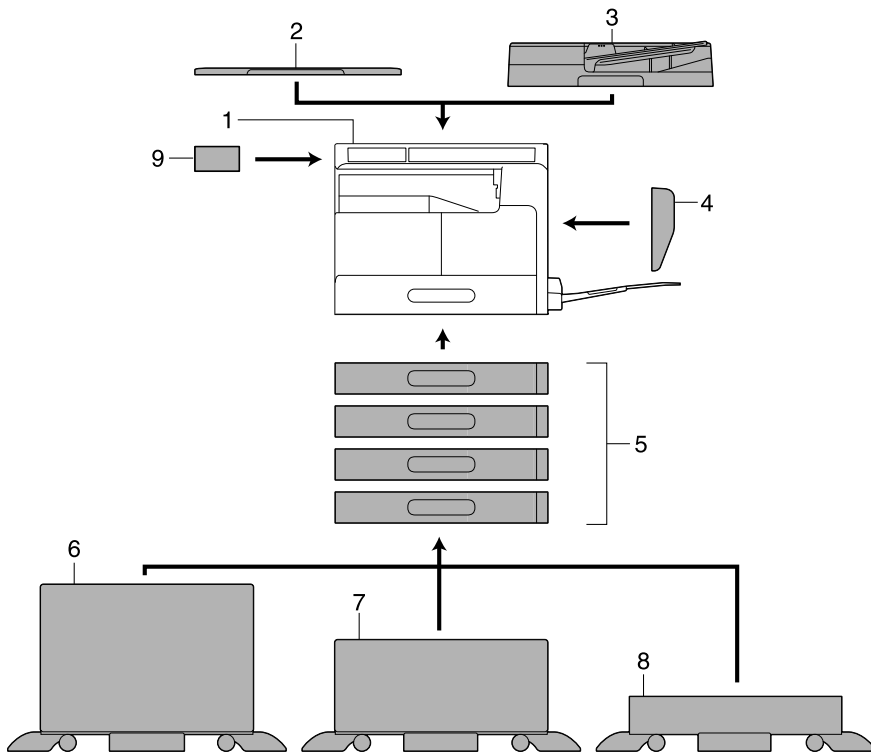

No.	Name	Description
1	Main unit	The original is scanned by the scanner section, and the scanned image is printed by the printer section. The main unit is hereinafter referred to as "this machine", "main unit", or bizhub 225i throughout this manual.
2	Original Cover OC-512	Fixes the loaded originals. This unit is hereinafter referred to as the Original Cover throughout this manual.
3	Reverse Automatic Document Feeder DF-633	Automatically feeds and scans originals by page. This unit automatically reverses and scans 2-sided originals. This unit is hereinafter referred to as the ADF through the manual.
4	Automatic Duplex Unit AD-509	This unit allows 1- or 2-sided printing from a 2-sided original.
5	Paper Feeder Unit PF-507	Up to 250 sheets can be loaded on this paper feeder unit. Up to four trays can be added to this machine. The unit is hereinafter referred to as Tray 2/Tray 3/Tray 4/ Tray 5 .
6	Desk DK-706	This machine can be installed on this desk. By using the desk, you can install this machine on the floor. One tray can be added on this desk. This desk is hereinafter referred to as the Desk throughout this manual.

No.	Name	Description
7	Desk DK-707	This machine can be installed on this desk. By using the desk, you can install this machine on the floor. Up to two trays can be added on this desk. This desk is hereinafter referred to as the Desk throughout this manual.
8	Desk DK-708	This machine can be installed on this desk. By using the desk, you can install this machine on the floor. Up to four trays can be added to this desk. This desk is hereinafter referred to as the Desk throughout this manual.
9	Extended Operation Panel MK-750	An address book registration number and address can be registered or recalled while using fax and scanning functions.
10	FAX Kit FK-510*	Allows this machine to function as a fax machine. Alternatively, it allows more telephone lines to be connected.

* Indicates a built-in option that is not shown in the above figure.



Using as a Copy Machine

3 Using as a Copy Machine

3.1 Copying an original

This section describes basic procedures for loading and copying an original.

- 1 Press the **Copy** key and load the original.
 - For details on how to load the original, refer to page 2-11.
- 2 Specify the image quality.



- Use the ▲/▼ key to select the correct setting, then press the **OK** key.
- For originals containing both text and a photo, select [TEXT/PHOTO].
- For originals containing only text, select [TEXT].
- For originals containing only photos, select [PHOTO].

- 3 Specify the density.

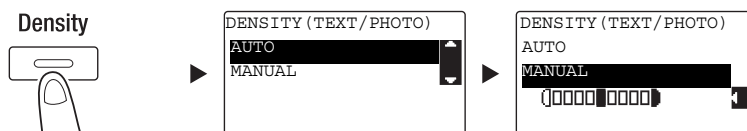

- Use the ▲/▼ key to select the correct setting, then press the **OK** key.
- When you select [MANUAL], use the ◀/▶ key to select the appropriate density, then press the **OK** key.
- In manual setting, you can select the density from nine different levels.
- You cannot specify the automatic density control and the [PHOTO] image quality setting at the same time.

- 4 Use the **Keypad** to specify the number of copies, then press the **Start** key.
 - When you load the original onto the **Original Glass**, repeat Steps 1 to 4.
 - To interrupt the copy operation being performed, press the **Clear/Stop** key. For details, refer to page 3-10.

3.2 Enlarging or reducing the original to a different size

When the size of the original differs from the printing paper size, you can specify the zoom ratio for copying.

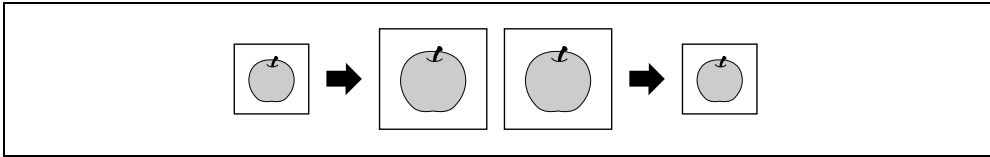

- 1 Press the **Copy** key and load the original.
 - For details on how to load the original, refer to page 2-11.
- 2 Press the **Zoom** key, then select [FIXED].

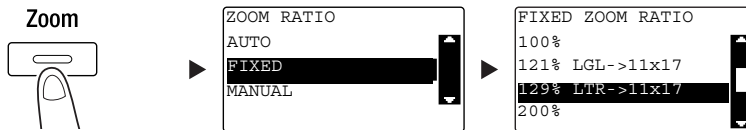

- Use the ▲/▼ key to select the correct zoom ratio, then press the **OK** key.
- Select the zoom ratio from 25%, 50%, 64%, 78%, 100%, 121%, 129%, 200%, and 400%.
- When you want to specify the zoom ratio from the **Keypad**, select [MANUAL].

- 3 Use the **Keypad** to specify the number of copies, then press the **Start** key.
 - To interrupt the copy operation being performed, press the **Clear/Stop** key. For details, refer to page 3-10.
 - When you load the original onto the **Original Glass**, repeat Steps 1 to 3.

Specifying the zoom ratio manually

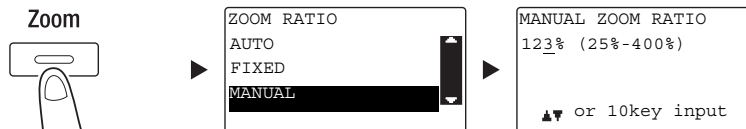

- Use the ▲/▼ key to select [MANUAL], then press the **OK** key.
- Use the ▲/▼ key, or the **Keypad** to enter the value, then press the **OK** key.

Tips

Pressing the **Clear/Stop** key deletes the value you have entered.

Reference

For details on setting the portrait and landscape zoom ratios, refer to Chapter 4 of the [User's Guide Copy].

3.3 Saving paper used for copying

This section describes procedures for printing on both sides of paper (2-sided copying) and for printing multiple reduced pages onto a single sheet (combined copying).

2-sided copying

When copying a large number of 1-sided originals, copying them onto both sides of each sheet reduces the amount of paper used by 50%.

The 2-sided copy function is only available when the optional **Automatic Duplex Unit AD-509** is installed.

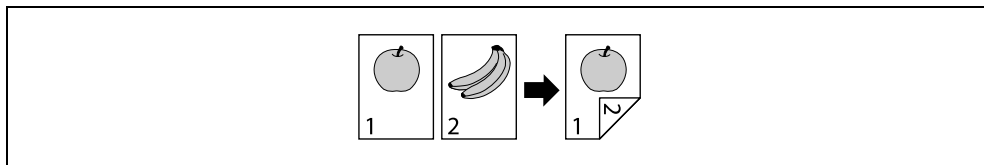

- 1 Press the **Copy** key and load the original.
 - For details on how to load the original, refer to page 2-11.
- 2 Configure the settings for 2-sided copying.

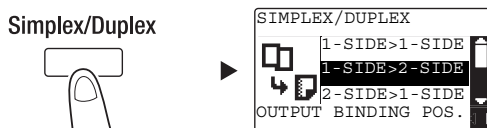

- Use the ▲/▼ key to select [1-SIDE → 2-SIDE], and press the **OK** key.
- When you select [1-SIDE → 2-SIDE] and press the ► key, you can specify the binding position for the printed sheets.

Tips

For [1-SIDE → 2-SIDE], [1-SIDE] refers to a 1-sided original, and [2-SIDE] refers to a 2-sided copy.

- 3 Use the **Keypad** to specify the number of copies, then press the **Start** key.
 - To interrupt the copy operation being performed, press the **Clear/Stop** key. For details, refer to page 3-10.
 - When you have loaded the original onto the **Original Glass**, go to Step 4.
- 4 When a message appears, load the next original then press the **OK** key.

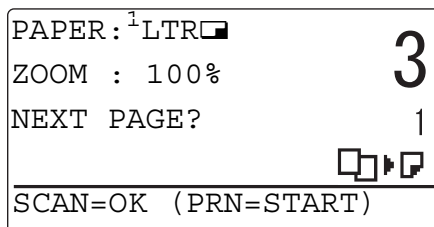

- 5 When all originals have been scanned, press the **Start** key.



Tips

The number of scanned pages is displayed under the number of copies.

Combined copying

The following describes the procedure for combining and printing multiple originals (two or four pages) onto a single page.

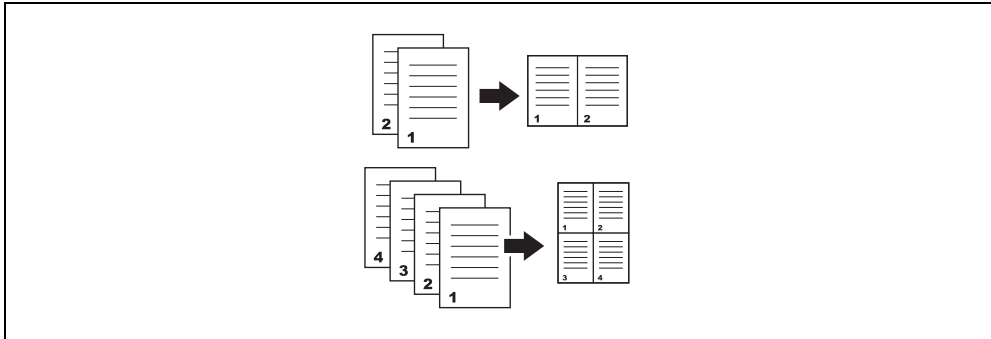

- 1 Press the **Copy** key and load the original.
 - For details on how to load the original, refer to page 2-11.
- 2 Press the **Combine Original** key and select [2in1] or [4in1].

Combine Original

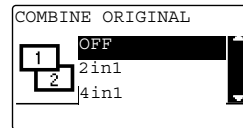

- When you select [2in1] and press the ► key, you can specify the original direction.
 - When you select [4in1] and press the ► key, you can specify the page order. When you press the ► key next, you can specify the original direction.
- 3 Use the **Keypad** to specify the number of copies, then press the **Start** key.
 - To interrupt the copy operation being performed, press the **Clear/Stop** key. For details, refer to page 3-10.
 - When you have loaded the original onto the **Original Glass**, go to Step 4.
 - 4 When a message appears, load the next original then press the **OK** key.

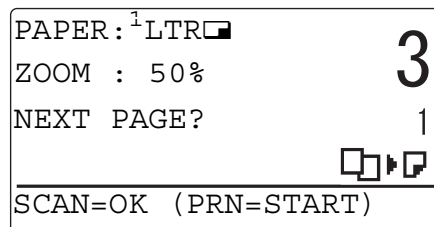

- 5 When all originals have been scanned, press the **Start** key.

Tips

The number of scanned pages is displayed under the number of copies.

3.4 Copying on custom sized paper

You can load custom sized paper into the **Bypass Tray** and **Tray 1**.

For Bypass tray

- 1 Press the **Copy** key and load the original.
 - For details on how to load the original, refer to page 2-11.
- 2 Load paper into the **Bypass Tray**.

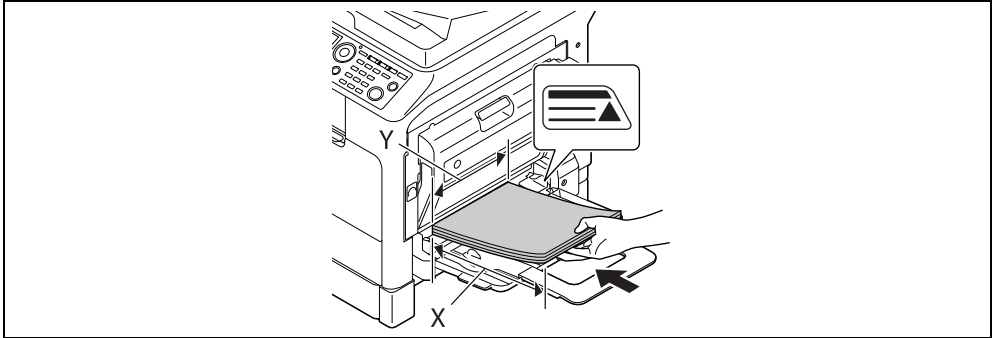

- Up to 100 sheets can be loaded into the **Bypass Tray**. Do not load the sheets of paper up to the point where the top of the stack is higher than the ▲ mark.
- When paper is loaded into the **Bypass Tray**, a screen for selecting the paper in the bypass tray appears on the **Control Panel**. Go to Step 3 to configure the settings for the custom sized paper.

- 3 Configure the settings for the custom sized paper.

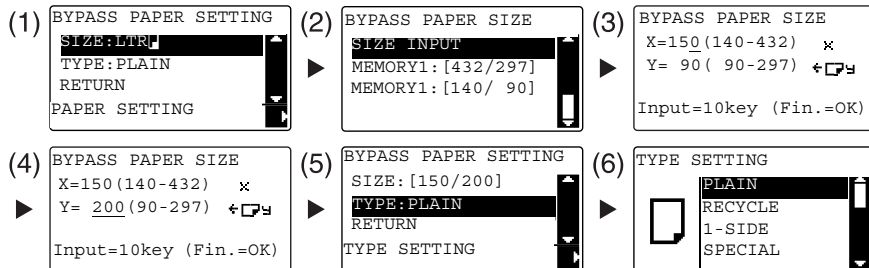

- Use the ▲/▼ key to select [SIZE], then press the ► key. (1)
- Use the ▲/▼ key to select the correct setting, then press the **OK** key. (2)(6)
- Use the **Keypad** to specify the paper size, then press the **OK** key. (3)(4)
- Use the ▲/▼ key to select [TYPE], then press the ► key. (5)
- Press the **Back** key to return to the basic screen.
- If you are not sure about the size of the custom sized paper, measure the X and Y lengths using the **Original Scale**.

- 4 Use the **Keypad** to specify the number of copies, then press the **Start** key.

For Tray 1

- 1 Press the **Copy** key and load the original.
→ For details on how to load the original, refer to page 2-11.
- 2 Load paper into the **Tray 1**.

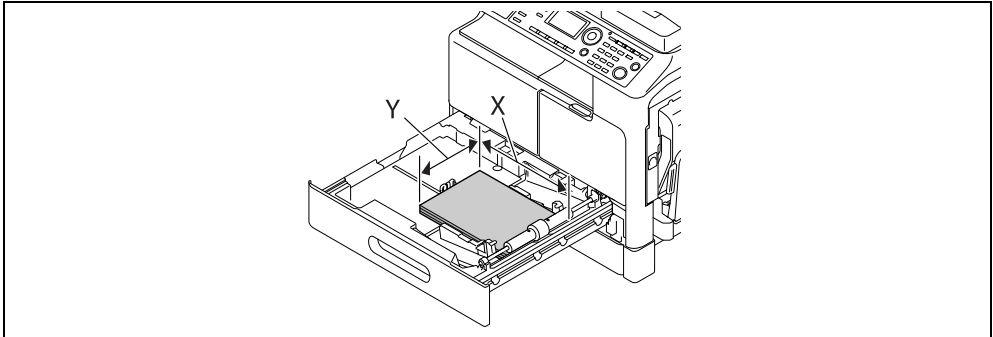

→ Slide the lateral guide to fit to the paper edge.

- 3 Configure the settings for the custom sized paper.

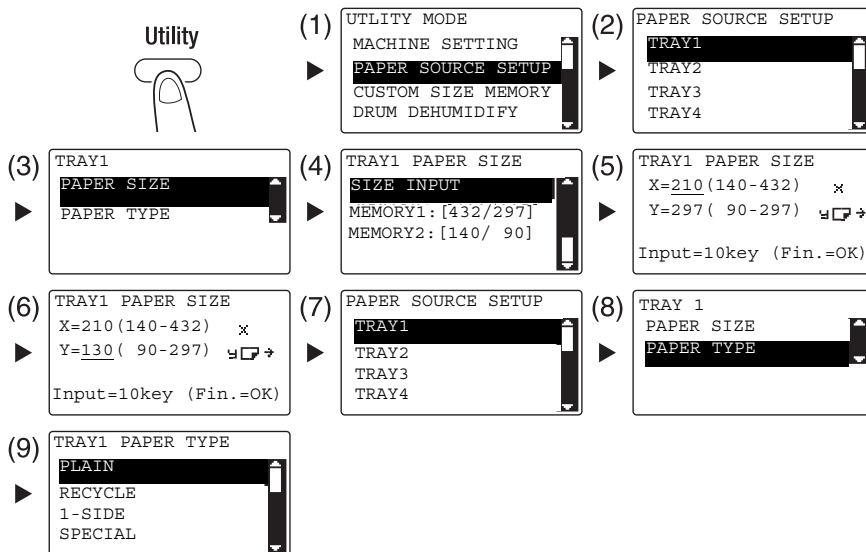

- Use the ▲/▼ key to select the correct setting, then press the **OK** key. (1)(2)(3)(4)(7)(8)(9)
- Use the **Keypad** to enter the paper size, then press the **OK** key. (5)(6)
- If you are not sure about the size of the custom sized paper, measure the length (X) and width (Y) using the **Original Scale**.

- 4 Use the **Keypad** to specify the number of copies, then press the **Start** key.

3.5 Making copies on envelopes

You can load envelopes into the **Bypass Tray** and **Tray 1**. As an example, this section describes procedures for loading envelopes into the **Bypass Tray** and copying the original onto the envelopes.

- 1 Press the **Copy** key and load the original.
 - For details on how to load the original, refer to page 2-11.
- 2 Load envelopes into the **Bypass Tray**.

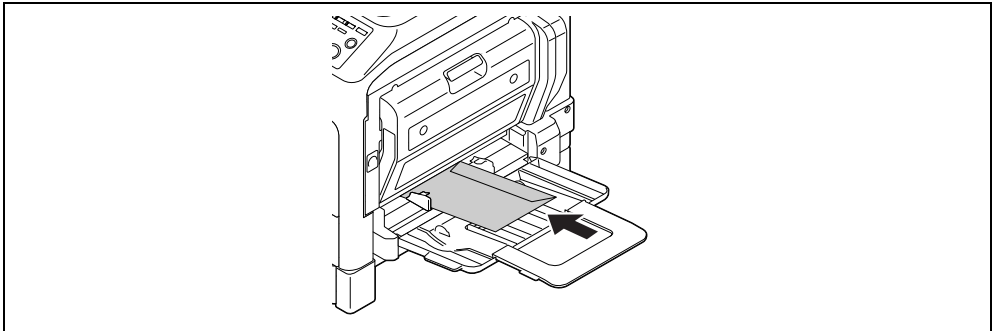

- Load the envelopes with the flap side facing up, so that the side on which you want to copy the original is facing down.
- Up to 10 envelopes can be loaded into the **Bypass Tray**.
- When envelopes are loaded into the **Bypass Tray**, a screen for specifying the paper appears on the **Control Panel**. Go to Step 3 to configure the settings.

- 3 Configure the settings for the envelopes.

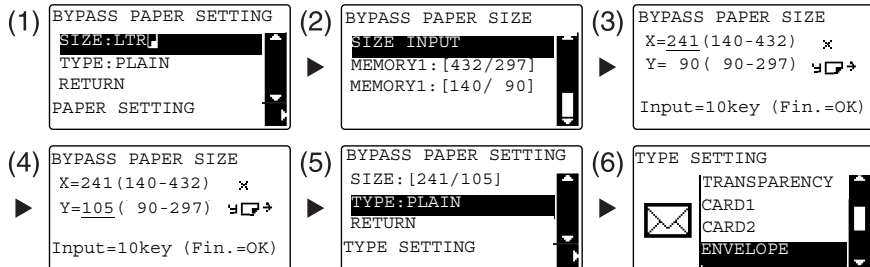

- Use the ▲/▼ key to select [SIZE], then press the ► key. (1)
- Use the ▲/▼ key to select the correct setting, then press the **OK** key. (2)
- Use the **Keypad** to specify the envelope size, then press the **OK** key. (3)(4)
- Use the ▲/▼ key to select [TYPE], press the ► key and select [ENVELOPE]. (5)(6)
- Press the **Back** key to return to the basic screen.
- If you are not sure about the size of the envelopes, measure the X and Y lengths using the **Original Scale**.

- 4 Use the **Keypad** to specify the number of copies, then press the **Start** key.



Reference

For details on configuring the settings for paper in **Tray 1**, refer to Chapter 6 of the [User's Guide Copy].

3.6 Canceling the ongoing copy operation

This section describes the procedure for canceling the copy operation that has been started by pressing the **Start** key.

- 1 Configure the copy settings then press the **Start** key.
- 2 Press the **Clear/Stop** key during copy operation.
The [Please Wait] message appears and the job stops.
- 3 Use the **▲/▼** key to select [YES], then press the **OK** key.

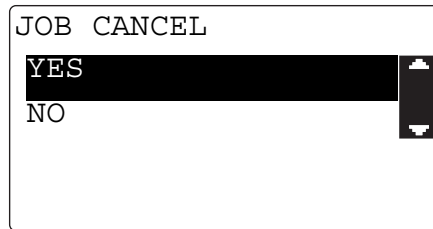

→ Selecting [NO] restarts the stopped job.

4

Using as a Fax Machine

4 Using as a Fax Machine

To use the fax function, optional **FAX Kit FK-510** and **Extended Operation Panel MK-750** are required.

4.1 Sending a fax

This section explains how to send a fax.

This machine supports the G3 fax function. Its sending and receiving are applicable only to G3-base remote machines.

- 1 Press the **Fax** key.
- 2 Load the original.
 - For details on how to load the original, refer to page 2-11.
- 3 Specify the image quality.

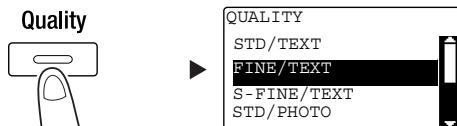

- Use the ▲/▼ key to select the correct setting, then press the **OK** key.
 - When sending a photo original, select [STD/PHOTO], [FINE/PHOTO], or [S-FINE/PHOTO].
 - If [S-FINE/TEXT] or [S-FINE/PHOTO] is selected, the original may not be sent as specified. In this case, the original is sent with [FINE/TEXT] or [STD/PHOTO].
 - When [FINE/PHOTO] or [S-FINE/PHOTO] is specified, if the original size is larger than the paper size of the destination, the image quality may be degraded depending on the performance of the destination fax machine.
- 4 Specify the density.



- Use the ◀/▶ key to specify the appropriate density, then press the **OK** key.
- 5 Enter a fax number using the **Keypad**, then press the **Start** key.
 - In the **AddressBook** key, you can find numbers registered in One-touch Dial or the speed dial.
 - When the desired number is registered in One-touch Dial, select the destination from One-touch Dial.
 - To specify a number registered in the speed dial, press the **Speed Dial** key then specify the speed dial number using the **Keypad**.
 - To interrupt the transmission, press the **Clear/Stop** key and select [YES] in the displayed screen. For details, refer to page 4-11.
 - When you have loaded the original onto the **Original Glass**, go to Step 6.

- 6 Use the ▲/▼ key to select [AUTO DETECTION] or [MANUAL], then press the **OK** key.
 - If [MANUAL] is selected, specify the paper size.

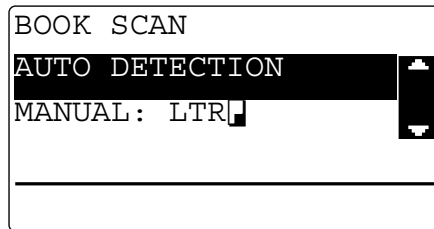

- 7 To start scanning, press the **OK** key.
- 8 When continuously scanning the original, load the next original, then press the **OK** key.
- 9 When scanning of all originals has been completed, press the **Start** key.
 - To interrupt the transmission, press the **Clear/Stop** key and select [YES] in the displayed screen. For details, refer to page 4-11.

4.2 Sending a fax to multiple destinations at the same time

Sequential broadcast transmission

The original can be sent to multiple destinations by one operation. This function is referred to as a sequential broadcast transmission.

You can specify multiple destinations using two methods. One is to enter the destinations using the **Keypad**, and the other is to select them from those registered. You can combine these two methods.

- 1 Press the **Fax** key and load the original.
 - For details on how to load the original, refer to page 2-11.
- 2 Specify the destinations.

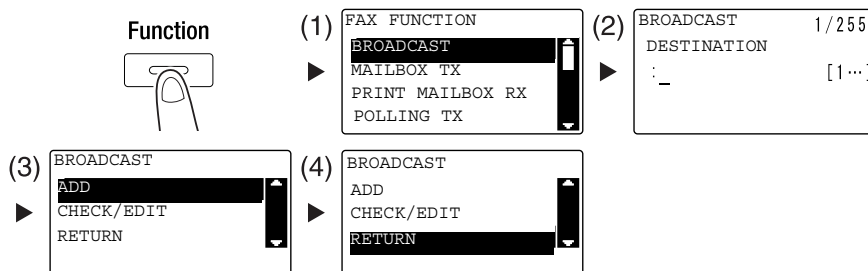

- Use the ▲/▼ key to select [BROADCAST], then press the **OK** key. (1)
 - Specify a destination, then press the **OK** key. (2)
 - Use the ▲/▼ key to select [ADD], then press the **OK** key. (3)
 - Repeat Steps (1) to (3) to specify all destinations.
 - When you have specified all destinations, select [RETURN] then press the **OK** key. (4)
 - To check the destinations, select [CHECK/EDIT].
- 3 Configure the other necessary settings then press the **Start** key.
 - When you have loaded the original onto the **Original Glass**, specify the scanning size. For details, refer to page 4-3.
 - To interrupt the transmission, press the **Clear/Stop** key and select [YES] in the displayed screen. For details, refer to page 4-11.

4.3 Checking fax communication results

After originals have been sent or received, communication result information (up to 60 items) are recorded.

1 Check the communication result.

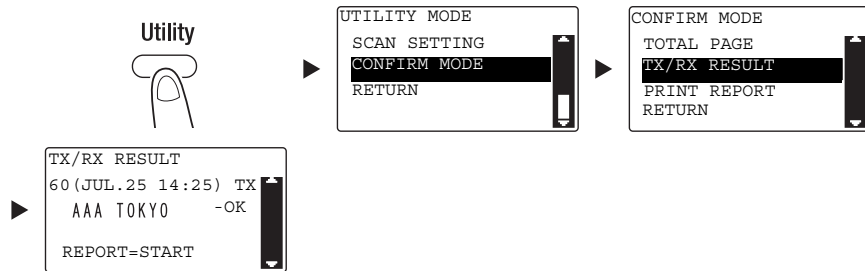

- Use the ▲/▼ key to select [CONFIRM MODE], then press the **OK** key.
- Use the ▲/▼ key to select [TX/RX RESULT], then press the **OK** key.
- Use the ▲/▼ key to view the desired communication result.
- To print a communication result report, press the **Start** key. After a communication result report has been printed, the basic screen appears.

2 Configure the settings for printing the report.

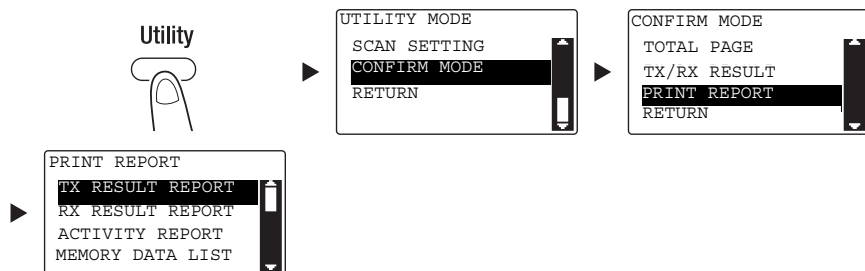

- Use the ▲/▼ key to select [CONFIRM MODE], then press the **OK** key.
- Use the ▲/▼ key to select [PRINT REPORT], then press the **OK** key.
- Use the ▲/▼ key to select the report you want to output, then press the **OK** key or the **Start** key.
- The following paper sizes are supported for printing out a report.
 5-1/2 × 8-1/2 □, 5-1/2 × 8-1/2 □/□, 8-1/2 × 11 □/□, 8-1/2 × 14 □, 11 × 17 □, A5 □, B5 □/□,
 A4 □/□, B4 □, and A3 □

3 Press the **Start** key.

4.4 Registering frequently used fax destinations

You can register frequently used destinations. You can register destinations in the One-touch Dial, speed dial, group dial, and program dial. This section describes how to register destinations in the One-touch Dial and speed dial.

Registering destinations in One-touch Dial

Register a destination in One-touch Dial; you can specify a destination easily and accurately without entering a fax number using the **Keypad**.

- 1 Press the **Utility** key, and select [DIAL REGISTRATION].

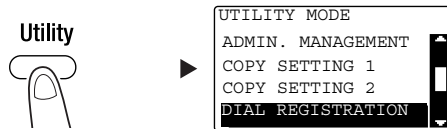

- Use the ▲/▼ key to select it, then press the **OK** key.

- 2 Select [ONE-TOUCH DIAL].

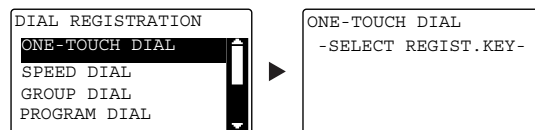

- Use the ▲/▼ key to select it, then press the **OK** key.
- For details on how to register destinations in the group dial, refer to Chapter 7 of the [User's Guide Fax].

- 3 Press the **One-Touch Dial Key** to register a destination in.

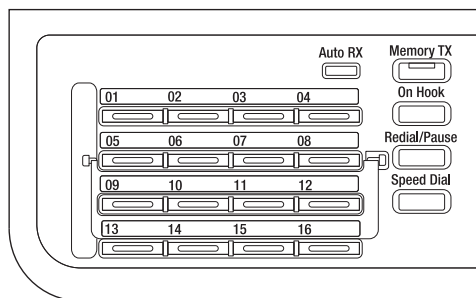

- Up to 32 stations can be registered in One-touch Dial.
- When the LDAP setting has been configured, select [MANUAL SETTING].

- 4 Enter the name and fax number of the destination using the **Keypad**, then press the **OK** key.

ONE-TOUCH DIAL 01 NAME : x_x_x [A...]	▶	ONE-TOUCH DIAL 01 DESTINATION : 0123 45 789_ [1...] OTHER SETTING=▼
---	---	--

- For how to enter characters, refer to page 4-10.
- To configure the F-Code TX, baud rate, or transmission time setting, refer to Chapter 7 of the [User's Guide Fax].

Registering destinations in the speed dial

Register a destination in the speed dial; you can specify a destination easily and accurately without entering a fax number using the **Keypad**.

- 1 Press the **Utility** key, and select [DIAL REGISTRATION].

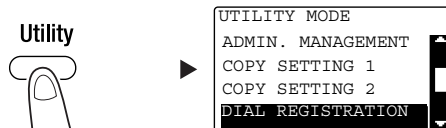

- Use the ▲/▼ key to select it, then press the **OK** key.

- 2 Select [SPEED DIAL].

DIAL REGISTRATION ONE-TOUCH DIAL SPEED DIAL GROUP DIAL PROGRAM DIAL	▶	
---	---	--

- Use the ▲/▼ key to select it, then press the **OK** key.
- For details on how to register destinations in the group dial, refer to Chapter 7 of the [User's Guide Fax].

- 3 Enter a desired 3-digit speed dial number using the **Keypad**, then press the **OK** key.

```
SPEED DIAL
SPEED DIAL : 001

-PRESS OK KEY-
```

- Up to 250 stations (001 to 250) can be registered in the speed dial.
- When the LDAP setting has been configured, select [MANUAL SETTING].

- 4 Enter the name and fax number of the destination using the **Keypad**, then press the **OK** key.

```
SPEED DIAL 01
NAME
:AAA OSAKA [A...] ►
SPEED DIAL 01
DESTINATION
:0123 45 789_ [1...]
OTHER SETTING=▼
```

- For how to enter characters, refer to page 4-10.
- To configure the F-Code TX, baud rate, or transmission time setting, refer to Chapter 7 of the [User's Guide Fax].

4.5 Entering characters

Use **A.../1...** to select the character to be entered. You can enter numerals (**1...**) and alphabetical letters (**A...**). Select and enter the character using the **Keypad**.

Entering characters using the Keypad

Example: Characters that can be entered by pressing the **2** key

[1...]: For entering numerals

Number of times pressed	1
Character entered	2

[A...]: For entering characters

Number of times pressed	1	2	3	4	5	6	7
Character entered	A	B	C	2	a	b	c

List of characters that can be entered from the Keypad

Keypad	Character entered	
	1...	A...
1	1	. (period), @, _ (underscore), - (hyphen), 1
2	2	A, B, C, 2, a, b, c, Ä, ä, Å, å, Æ, æ, à, Ç, ç
3	3	D, E, F, 3, d, e, f, É, é, è
4	4	G, H, I, 4, g, h, i, ì, í, î
5	5	J, K, L, 5, j, k, l
6	6	M, N, O, 6, m, n, o, Ñ, ñ, Ö, ö, Ø, ø, ò
7	7	P, Q, R, S, 7, p, q, r, s, ß
8	8	T, U, V, 8, t, u, v, Ü, ü, ù, ú
9	9	W, X, Y, Z, 9, w, x, y, z
0	0	(space), 0
#	#	(+), &, /, *, =, !, ?, (,), %, [], ^, ` , ' , { }, , ~, \$, , (comma), ;, :, <, >, ", ' , £

Entering more than one character



After entering a character, press the ◀▶ key to move the cursor.

After entering all necessary characters, press the **OK** key.

Tips

- To delete all characters you have entered, press the **Back** key to return to the previous screen.
- To delete one character, move the cursor to the character you want to delete, then press the **Clear/Stop** key.

4.6 Canceling the ongoing transmission

This section describes procedures for stopping the transmission that has been started by pressing the **Start** key or for canceling the transmission during redialing.

- 1 Press the **Clear/Stop** key during transmission.
- 2 Use the **▲/▼** key to select [YES], then press the **OK** key.

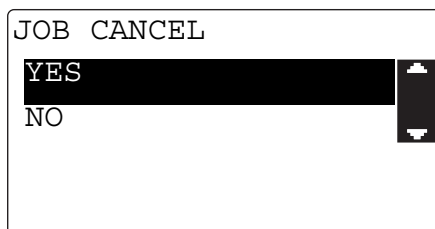









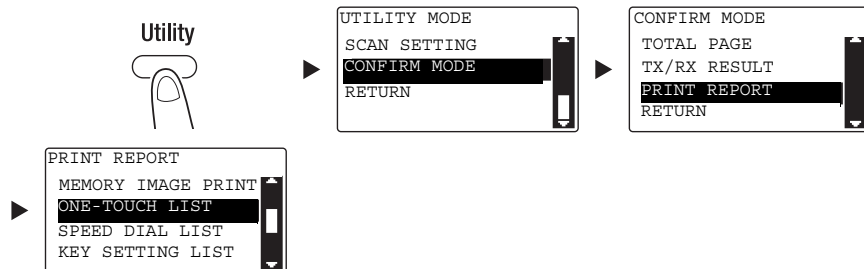

- Selecting [NO] restarts the fax transmission.
A transmission result report is printed out.

4.7 Checking the registered destinations

You can print a list of destinations that are registered in the One-touch Dial or speed dial on this machine. This section describes the procedure for printing a report on the destinations that are registered in this machine.

- 1 Check the registered destinations.



- Use the ▲/▼ key to select [CONFIRM MODE], then press the **OK** key.
- Use the ▲/▼ key to select [PRINT REPORT], then press the **OK** key.
- Select [ONE-TOUCH LIST] to check the destinations registered in the One-touch Dial list.
- Select [SPEED DIAL LIST] to check the destinations registered in the speed dial list.
- Select [KEY SETTING LIST] to check the settings of the group dial numbers and program dial numbers registered in the One-touch Dial keys.
- The following paper sizes are supported for printing out a report.
 5-1/2 × 8-1/2 , 5-1/2 × 8-1/2 , 8-1/2 × 11 , 8-1/2 × 14 , 11 × 17 , A5 , B5 ,
 A4 , B4 , and A3 



- 2 Press the **Start** key.

4.8 Sending data in the computer directly as a fax without leaving the desk

PC-FAX

You can send data created in your computer to a destination fax machine using an operation similar to that for printing the data.

To use the PC-FAX function, you must install the fax driver.

- 1 Create data to be sent using application software.
- 2 In the [File] menu, select [Print].
- 3 In [Printer Name], select the [KONICA MINOLTA XXX (FAX)] that is installed.
- 4 If necessary, click [Properties] (or [Preferences]), and change the fax driver settings.
- 5 Click [Print].
The [Destination Settings] screen appears.
- 6 Specify the destination.
 - To directly enter a destination, type the name and fax number into [Name] and [Fax Number], and click . (1)(3)
 - To search for a destination in the address book, select a target from the list, then click . (2) (3)
 - Right-click the group name of the address book to display the users registered in the group.
- 7 To specify multiple destinations, repeat Step 6.
- 8 Click [OK]. (4)

4.9 If you suspect a failure then do the following

If fax transmission or reception fails, check the corresponding item in the following table.

Cannot send a fax correctly

Fax status	Major cause	Correction action
The original is not scanned.	Is the original too thick?	Load the original onto the Original Glass . For details, refer to [User's Guide Copy].
	Is the original too thin or small?	Load the original onto the Original Glass . For details, refer to [User's Guide Copy].
	Is the Original Glass dirty?	Wipe the Original Glass with a soft, dry cloth.
The original is scanned obliquely.	Does the Lateral Guide match the original width?	Adjust the Lateral Guide to the original width. For details, refer to [User's Guide Copy].
An unclear image has been received at a destination.	Is the original positioned correctly?	Position the original correctly. For details, refer to [User's Guide Copy].
	Is the Original Glass dirty?	Wipe the Original Glass with a soft, dry cloth.
	Is the original text too faint?	Specify the scanning density. For details, refer to [User's Guide Fax].
	Is there a problem with the line status or destination fax?	Make a copy in this machine to check the result. If a copy image is clear, send a fax again.
A blank image has been received at a destination.	Is the original loaded, turning down the original side to be sent? (in use of ADF)	Load the original, turning up the original side to be sent. Then, send the original again. For details, refer to [User's Guide Copy].
Cannot send a fax automatically.	Was the number called correct?	Check the number.
	Did you call a telephone-dedicated number?	Check the number.
	Was there any problem at the recipient end? (Paper out, Auto RX is disabled, the power is not turned off, and other causes)	Check with the sender.

Cannot receive a fax correctly

Fax status	Major cause	Correction action
The received image is not clear.	Was the specified paper used?	Use the specified paper.
	Is the paper damp?	Replace with new paper.
	Is there a sufficient amount of toner?	Install a new Toner Bottle . For details, refer to page 2-20.
	Is there a problem with a destination fax?	Make a copy in this machine to check the result. If a copy image is clear, ask the sender to send the fax again.
Blank paper is received.	Is there a sufficient amount of toner?	Install a new Toner Bottle . For details, refer to page 2-20.
	Did the sender load the original the wrong way?	Check with the sender.
A fax is not received automatically.	Is Receive Mode set to Manual RX?	Set to Auto RX. For details, refer to [User's Guide Fax].
	Is the memory full?	If a paper out occurs, add paper and print out files saved in the memory.
	Is a message displayed?	Release the message as instructed in the screen.
Black lines have been printed on the received paper.	Is there a problem with a destination fax?	Make a copy in this machine to check the result. If a copy image is clear, ask the sender to send the fax again.

Cannot call correctly

Fax status	Major cause	Correction action
No sound is heard through an external phone.	Is the telephone cord connected to this machine?	Connect the telephone cord to this machine.
	Is the line cable connected to this machine?	Connect the line cable to this machine.
	During communication.	After a communication has ended, check the connection again.
Cannot hear no tone after dialing.	Is the line type specified correctly?	Specify the correct line type. For details, refer to [User's Guide Fax].
Difficult to hear the recipient's voice in on-hook dial mode.	Is the monitor volume low?	Adjust the monitor volume to the higher level. For details, refer to [User's Guide Fax].
The phone ring volume is low or high.	Is the ring volume of the external phone set to a low or high level?	Adjust the ring volume of the external phone.



Using as a Printer

5 Using as a Printer

5.1 Before Printing

To print from your computer, you must install the printer driver in your computer in advance.

You can easily install the printer driver using the installer contained on the accompanying CD/DVD-ROM.



Reference

For details on how to install the printer driver, refer to Chapter 3 of the [User's Guide Print].

5.2 Printing

Printing data

The following describes the procedure for printing data in your computer from this machine.

- 1 In the software, select the Print menu.
- 2 Select the printer and open [Preferences] (or [Properties]).
- 3 Configure the print settings then click [OK].
- 4 Click [Print].

5.3 Enlarging or reducing the original to fit the paper size

By specifying the paper size set for the data in the computer and the paper size to be set in the driver, you can enlarge or reduce the original to the paper size.

- 1 Select the printer and open [Preferences] (or [Properties]).
- 2 Select the original size.

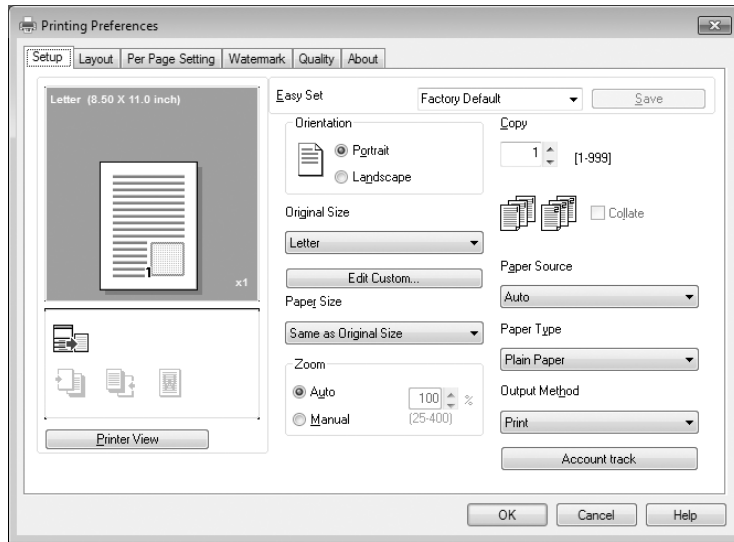

→ In [Original Size], specify the original size.

- 3 Specify the output paper size or zoom ratio.

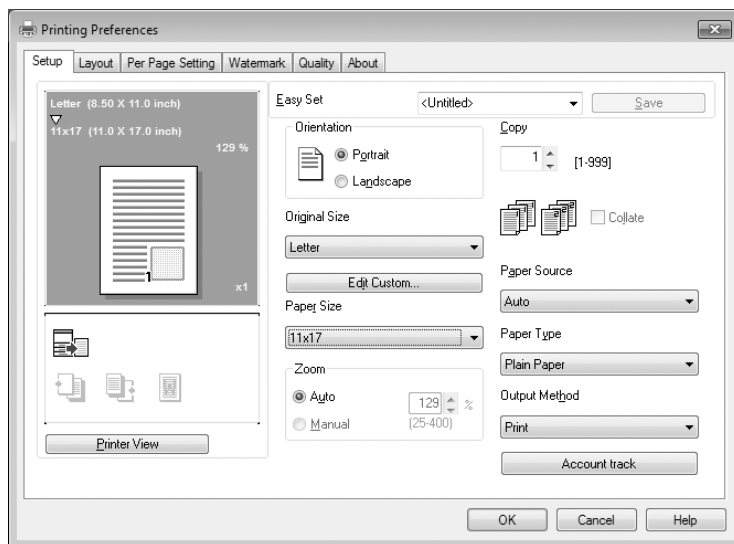

→ To specify the zoom ratio, select [Manual] and specify the zoom ratio.

- 4 Click [OK].

5.4 Saving paper used for printing

2-sided printing

Documents can be printed on both sides of paper.

- 1 Select the printer and open [Preferences] (or [Properties]).
- 2 Configure the settings for 2-sided printing.

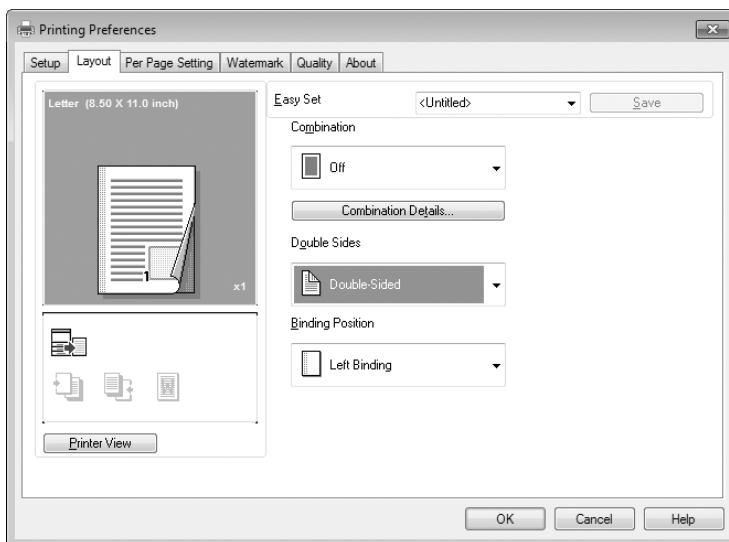

- Select [Layout] and configure the [Double-Sided] setting.
- Selecting [Double-Sided] prints the document on both sides of paper.
- Selecting [Single-Sided] prints the document on one side of paper.

- 3 Click [OK].

Combined printing

When printing multiple pages, you can select the number of pages to be printed onto a single sheet.

You can print 2, 4, 6, 9, or 16 pages of an original onto a single sheet.

- 1 Select the printer and open [Preferences] (or [Properties]).
- 2 Configure the settings for combined printing.

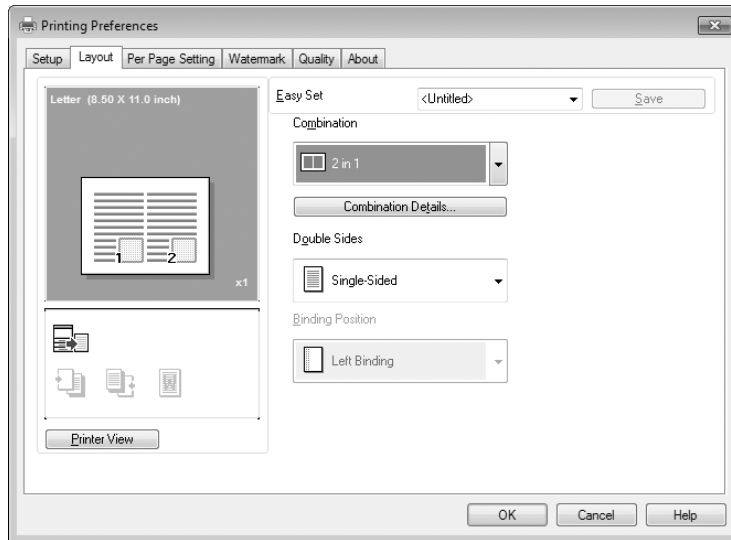

- Select [Layout] and configure the [Combination] setting.
- To specify the detailed settings for combination, click [Combination Details].

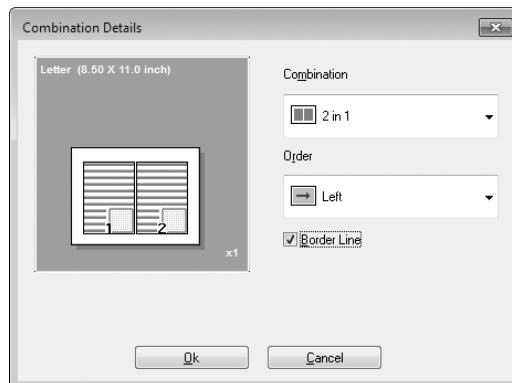

- In [Combination], you can specify the number of pages of the original to be printed on one page.
- In [Order], you can specify the order of combined pages.
- Select the [Border Line] check box to enclose each original page with a frame.

- 3 Click [OK].

5.5 Printing on custom sized paper

When printing on custom sized paper, load the paper into the **Bypass Tray** or **Tray 1**.

When using the Bypass Tray

- 1 Load paper.

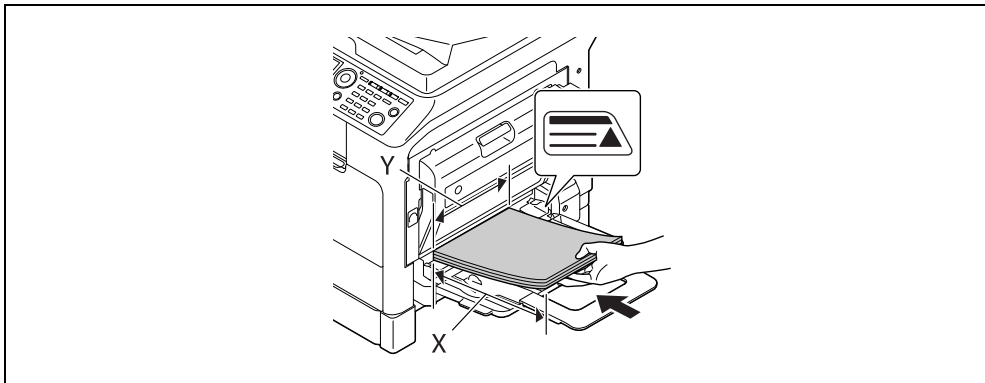

→ When the paper is loaded, a screen for specifying the paper in the **Bypass Tray** appears on the **Control Panel**. Go to Step 2 to configure the settings for the custom sized paper.

- 2 Configure the settings for the custom sized paper.

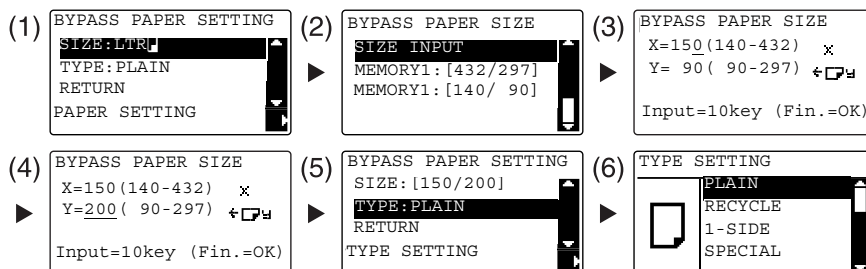

- Use the ▲/▼ key to select [SIZE], then press the ► key. (1)
- Use the ▲/▼ key to select the correct setting, then press the **OK** key. (2)(6)
- Use the **Keypad** to enter the paper size, then press the **OK** key. (3)(4)
- Use the ▲/▼ key to select [TYPE], then press the ► key. (5)
- Press the **Back** key to return to the basic screen.
- If you are not sure about the size of the custom sized paper, measure the length (X) and width (Y) using the **Original Scale**.

- 3 Select the printer and open [Preferences] (or [Properties]).
 - When the size of the loaded paper is not registered, select [Edit Custom] and register the paper size specified in the main unit.

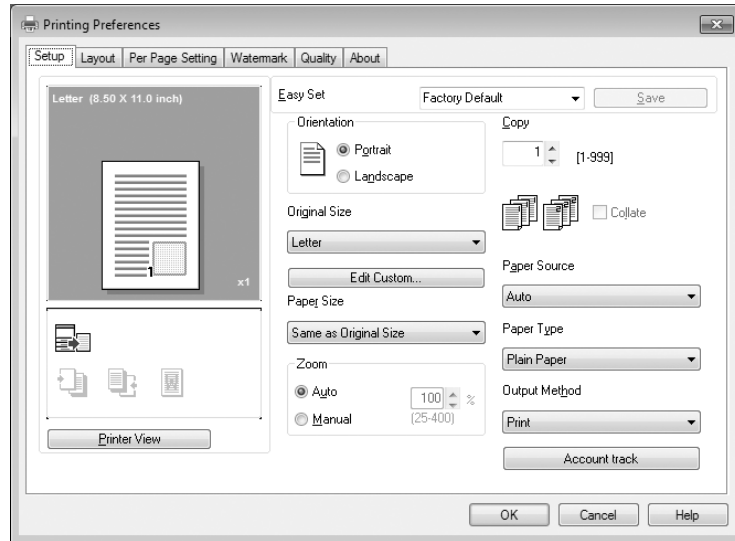

- Click [New].

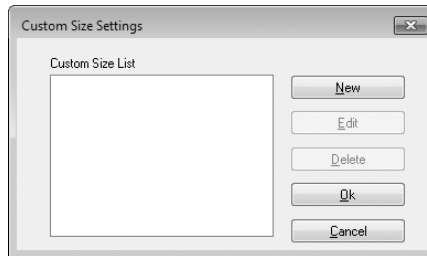

- Enter the name in [Name] and dimensions in [Dimensions], then click [OK]. Select the registered paper size then click [OK].

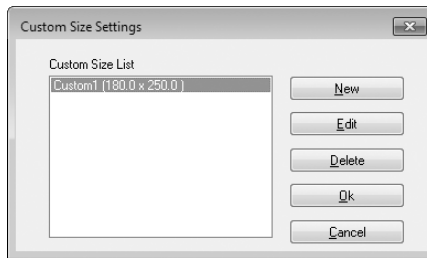
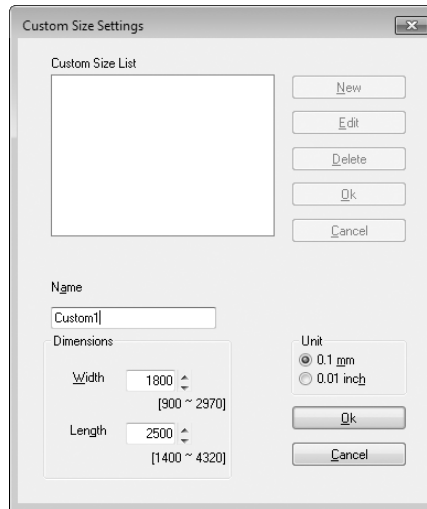

- In [Original Size], select the custom sized paper that is registered.
 → In [Paper Source], select [Bypass].

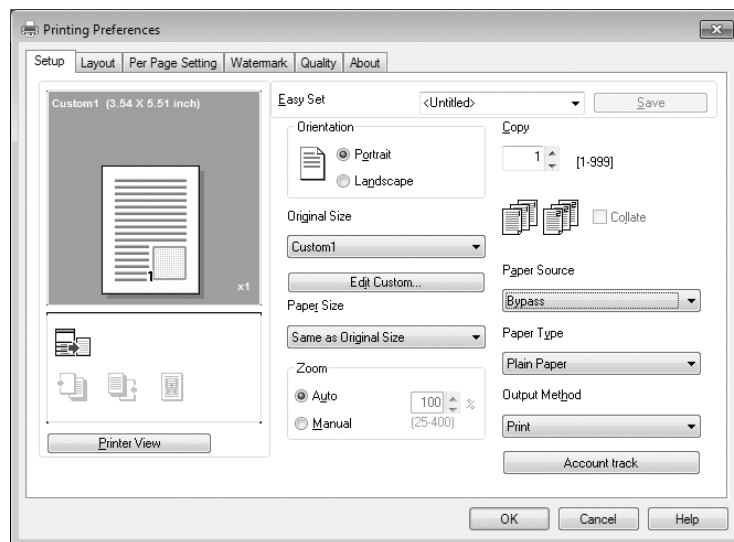

→ Check that [Paper Size] is set to the same size as the paper setting for the data to be printed.

4 Click [OK].

When using Tray 1

1 Load paper.

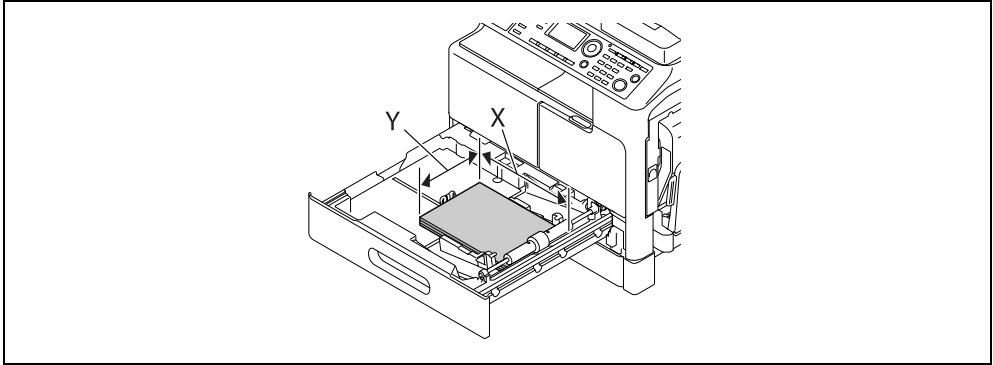

→ If you are not sure about the size of the custom sized paper, measure the length (X) and width (Y) using the **Original Scale**.

2 Configure the settings for the custom sized paper.

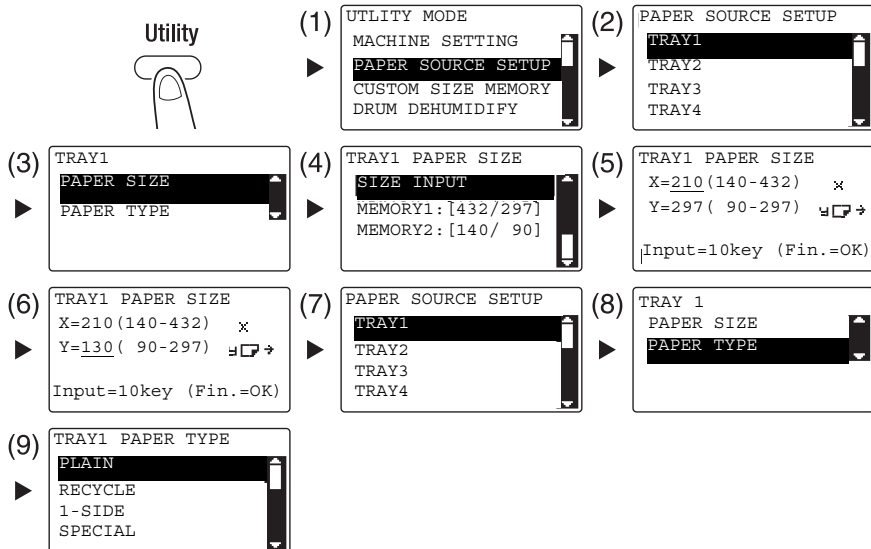

→ Use the ▲/▼ key to select the correct setting, then press the **OK** key. (1)(2)(3)(4)(7)(8)(9)

→ Use the **Keypad** to enter the paper size, then press the **OK** key. (5)(6)

→ If you are not sure about the size of the custom sized paper, measure the length (X) and width (Y) using the **Original Scale**.

- 3 Select the printer and open [Preferences] (or [Properties]).
 - When the size of the loaded paper is not registered, select [Edit Custom] and register the paper size specified in the main unit.

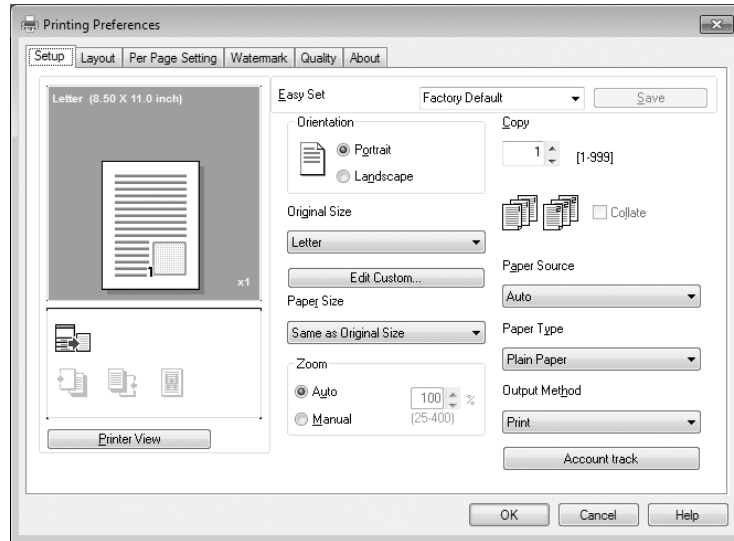

- Click [New].

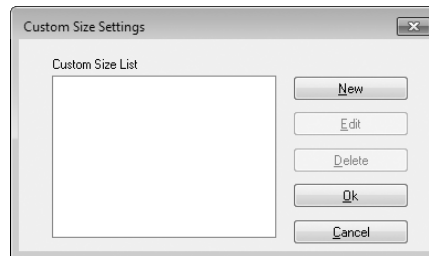

- Enter the name in [Name] and dimensions in [Dimensions], then click [OK]. Select the registered paper size then click [OK].

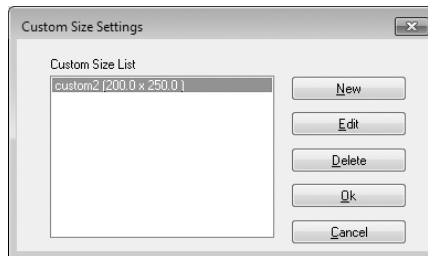
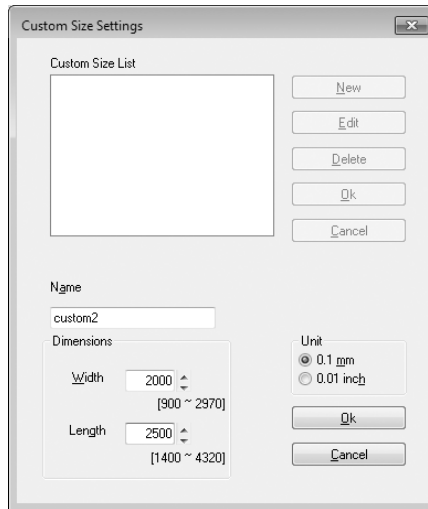

- In [Original Size], select the custom sized paper that is registered.
- In [Paper Source], select [Tray 1].

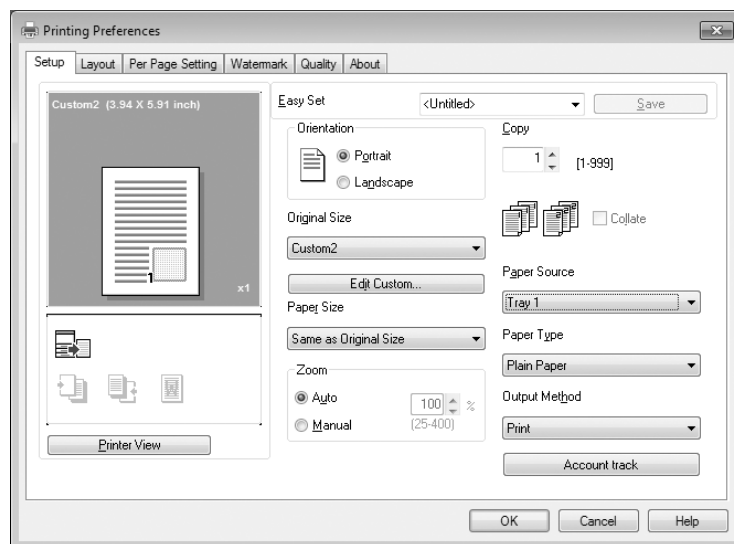

- Check that [Paper Size] is set to the same size as the paper setting for the data to be printed.

4 Click [OK].

5.6 Printing on envelopes

To print on envelopes, you need to specify the size and type of paper in **Control Panel** and select the envelope size in the data to be printed or in the printer driver.

When using the Bypass Tray

1 Load envelopes.

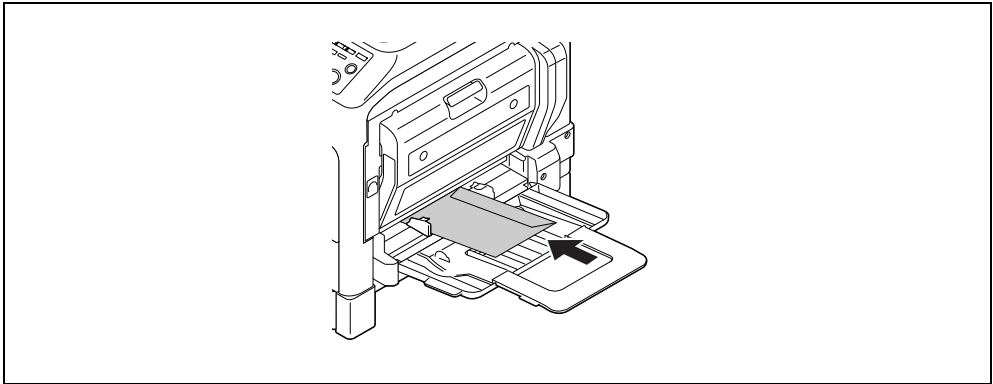

- Load the envelopes with the flap side facing up.
- Up to 10 envelopes can be loaded.
- When the paper is loaded, a screen for specifying the paper in the **Bypass Tray** appears on the **Control Panel**. Go to Step 2 to configure the settings for the envelopes.

2 Configure the settings for the envelopes.

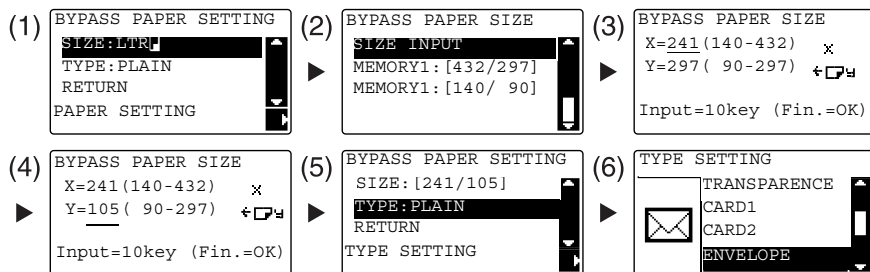

- Use the ▲/▼ key to select [SIZE], then press the ► key. (1)
- Use the ▲/▼ key to select the correct setting, then press the **OK** key. (2)
- Use the **Keypad** to enter the paper size, then press the **OK** key. (3)(4)
- Use the ▲/▼ key to select [TYPE], then select the ► key. (5)
- Select [ENVELOPE]. (6)
- Press the **Back** key to return to the basic screen.
- If you are not sure about the size of the envelopes, measure the length (X) and width (Y) using the **Original Scale**.

- 3 Select the printer and open [Preferences] (or [Properties]).
 - The envelope sizes registered in the printer driver are [Env.Com10], [Env.C6 3/4], [Env.C6], and [Env.DL].
 - In [Original Size], select the envelope size.

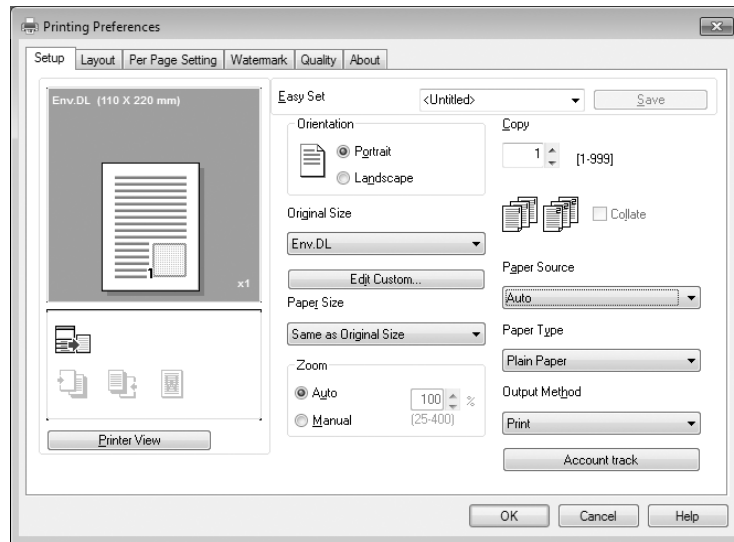

- In [Paper Source], select [Bypass].

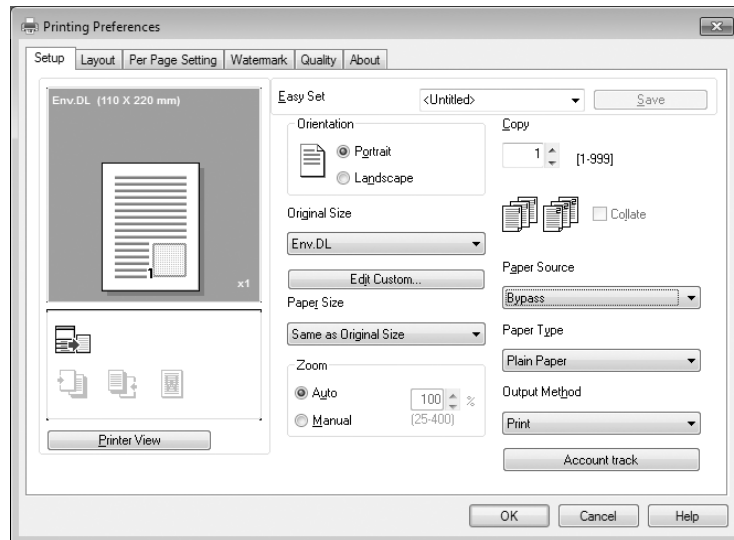

→ In [Paper Type], select [Envelope Paper].

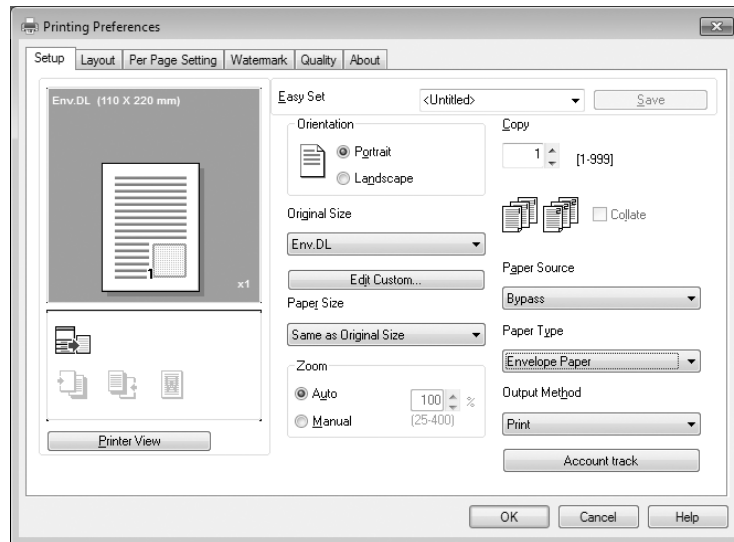

→ Check that [Paper Size] is set to the same size as the paper setting for the data to be printed.

4 Click [OK].

When using Tray 1

1 Load envelopes.

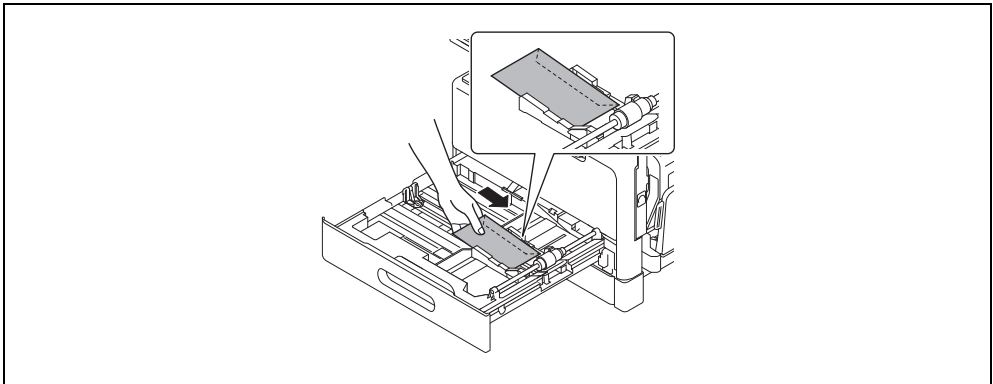

- Load them with the side you want to print facing up.
- Up to 10 envelopes can be loaded.

2 Configure the settings for the envelopes.

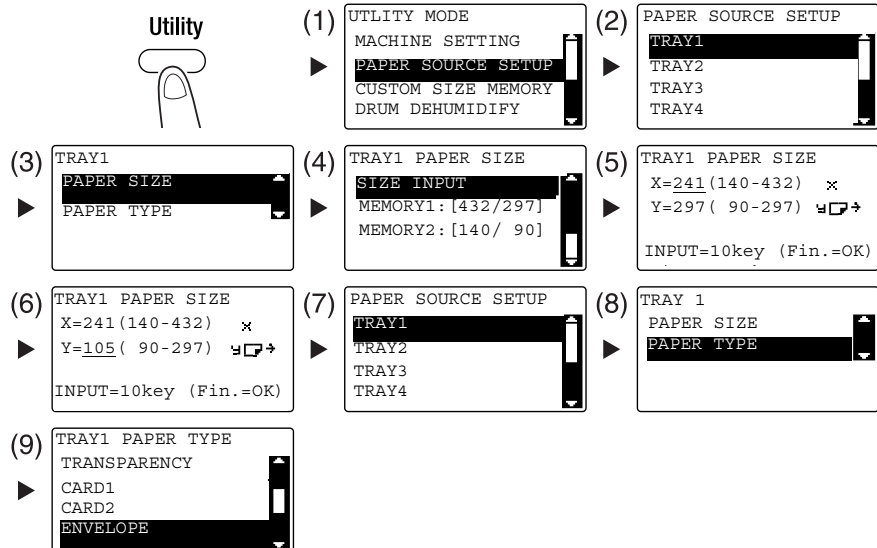

- Use the ▲/▼ key to select the correct setting, then press the **OK** key. (1)(2)(3)(4)(7)(8)(9)
- Use the **Keypad** to enter the paper size, then press the **OK** key. (5)(6)
- If you are not sure about the size of the envelopes, measure the length (X) and width (Y) using the **Original Scale**.

- 3 Select the printer and open [Preferences] (or [Properties]).
 - The envelope sizes registered in the printer driver are [Env.Com10], [Env.C6 3/4], [Env.C6], and [Env.DL].
 - In [Original Size], select the envelope size.

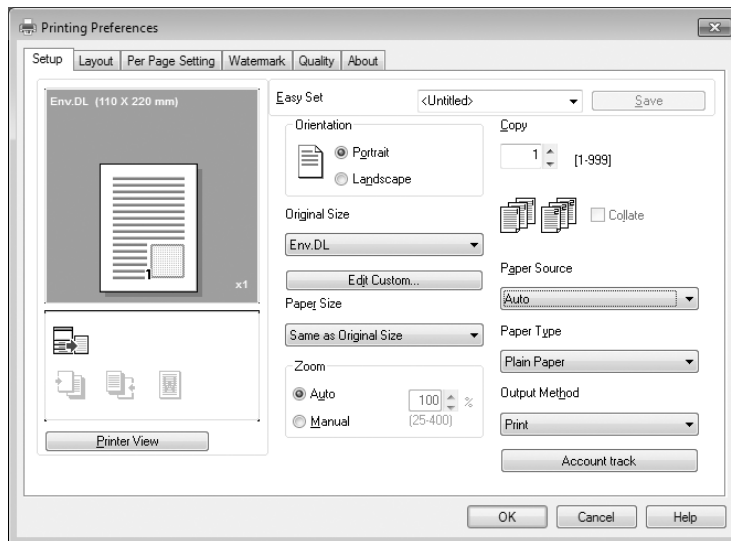

- In [Paper Source], select [Tray 1].

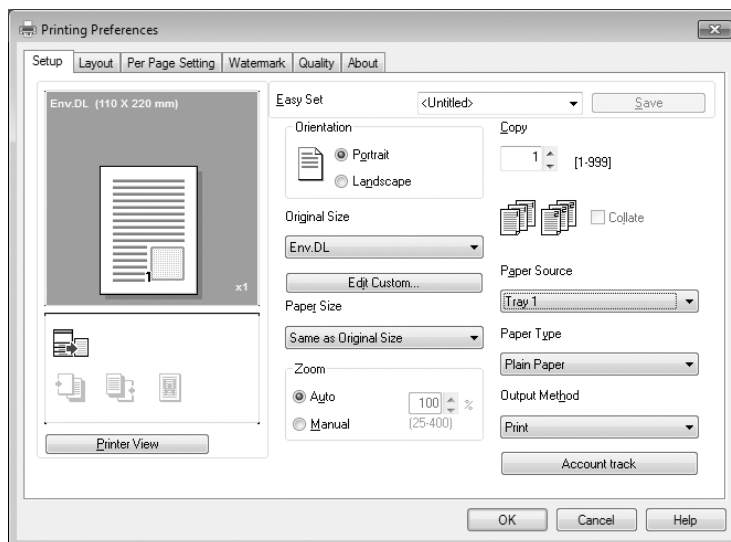

→ In [Paper Type], select [Envelope Paper].

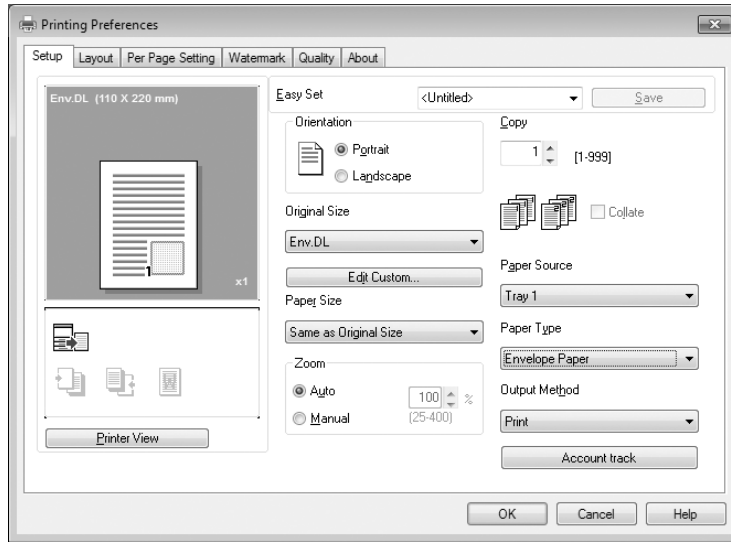

→ Check that [Paper Size] is set to the same size as the paper setting for the data to be printed.

4 Click [OK].

6

Using as a Scanner

6 Using as a Scanner

6.1 Sending scanned data

Scanned data can be sent via an E-mail or to the FTP or SMB server.

Tips

To select the destination using the One-touch, Speed dial, or Group dial, **Extended Operation Panel MK-750** must be installed.

Sending an E-mail

The following describes the procedure for sending scanned data via an E-mail.

- 1 Press the **Scan** key.
- 2 Load the original.
 - For details on how to load the original, refer to page 2-11.
- 3 Specify the resolution setting.

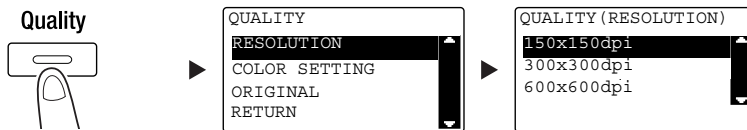

- Use the ▲/▼ key to select the correct setting, then press the **OK** key.
- Select [150×150dpi], [300×300dpi], or [600×600dpi].
- When [Color] or [Gray] is specified for the color setting, [600×600dpi] is not displayed.

- 4 Specify the color setting.

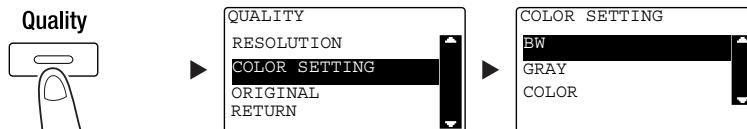

- Use the ▲/▼ key to select the correct setting, then press the **OK** key.
- Select [BW], [GRAY], or [COLOR].
- If [BW] is selected with [Image Format] set to [JPEG], [PDF] is automatically selected.

5 Specify the image quality.

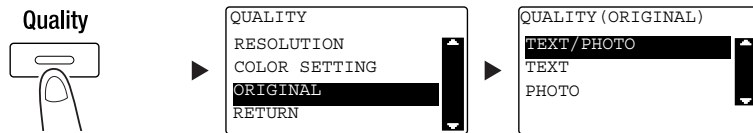

- Use the ▲/▼ key to select the correct setting, then press the **OK** key.
- Select [TEXT/PHOTO], [TEXT], or [PHOTO].

6 Enter the E-mail address using the **Keypad**, then press the **Start** key.

- The subject, CC address, file format, and compression coding method can be specified.
- One-touch Dial can be used to select the destination.
- The speed dial can be used to select the destination.
- The address book can be used to select the destination.
- To interrupt the transmission, press the **Clear/Stop** key then select [YES] in the displayed screen. For details, refer to page 6-10.
- For details on each setting, refer to Chapter 5 of the [User's Guide Scan].
- When you have loaded the original onto the **Original Glass**, go to Step 7.

7 Use the ▲/▼ key to select [AUTO DETECTION] or [MANUAL], then press the **OK** key.

- When you select [MANUAL], you can specify the scanning size.

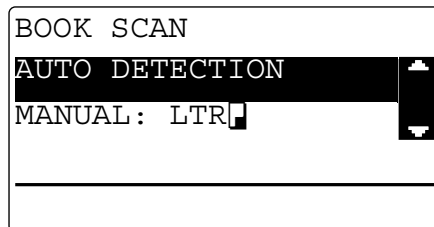

8 To start scanning, press the **OK** key.

9 When continuously scanning the original, load the next original, then press the **OK** key.

10 When scanning of all originals has been completed, press the **Start** key.

- To interrupt the transmission, press the **Clear/Stop** key and select [YES] in the displayed screen. For details, refer to page 6-10.

Sending scanned data to the FTP/SMB server

The following describes the procedure for sending scanned data to the FTP/SMB server.

- 1 Press the **Scan** key.
- 2 Load the original.
 - For details on how to load the original, refer to page 2-11.
- 3 Specify the resolution setting.

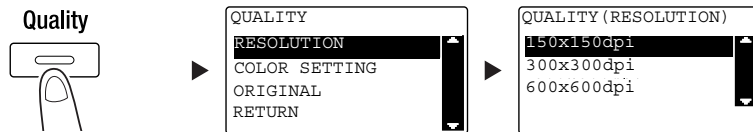

- Use the ▲/▼ key to select the correct setting, then press the **OK** key.
- Select [150x150dpi], [300x300dpi], or [600x600dpi].
- When [Color] or [Gray] is specified for the color setting, [600x600dpi] is not displayed.

- 4 Specify the color setting.

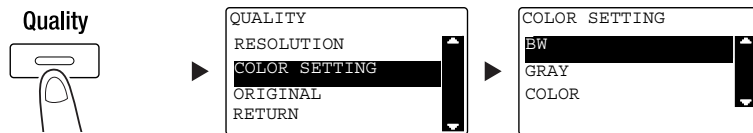

- Use the ▲/▼ key to select the correct setting, then press the **OK** key.
- Select [BW], [GRAY], or [COLOR].
- If [BW] is selected with [Image Format] set to [JPEG], [PDF] is automatically selected.

- 5 Specify the image quality.

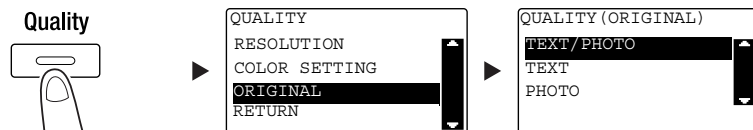

- Use the ▲/▼ key to select the correct setting, then press the **OK** key.
- Select [TEXT/PHOTO], [TEXT], or [PHOTO].

- 6 Press the **Speed Dial** key. Enter a 3-digit dial number using the **Keypad**, then press the **OK** key.

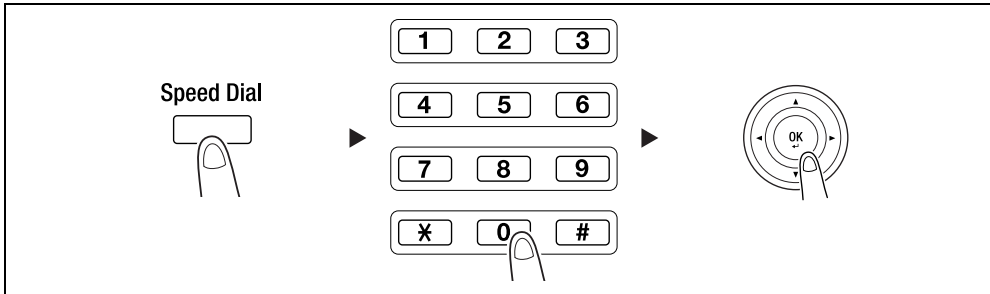

- Before sending data to the server, register the FTP/SMB server address using a number between [251 and 300] on the speed dial.
- You can select an address using **AddressBook** key. For details, refer to Chapter 5 of the [User's Guide Scan].
- The file format and compression coding method can be specified. For details, refer to Chapter 6 of the [User's Guide Scan].

- 7 Press the **Start** key.

- To interrupt the transmission, press the **Clear/Stop** key then select [YES] in the displayed screen. For details, refer to page 6-10.
- When you have loaded the original onto the **Original Glass**, go to Step 8.

- 8 Use the **▲/▼** key to select [AUTO DETECTION] or [MANUAL], then press the **OK** key.

- When you select [MANUAL], you can specify the scanning size.

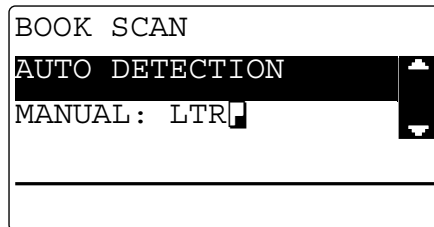

- 9 To start scanning, press the **OK** key.

- 10 When continuously scanning the original, load the next original, then press the **OK** key.

- 11 When scanning of all originals has been completed, press the **Start** key.

- To interrupt the transmission, press the **Clear/Stop** key and select [YES] in the displayed screen. For details, refer to page 6-10.

6.2 Registering frequently used destinations

You can register frequently used destinations. You can register destinations in the One-touch Dial, speed dial, group dial, and program dial. This section describes how to register destinations in the One-touch Dial and speed dial.

Tips

To register the destination from **Control Panel**, **Extended Operation Panel MK-750** must be installed.

Registering destinations in One-touch Dial

Register a destination in One-touch Dial; you can specify a destination easily and accurately without entering an E-mail address using the **Keypad**.

- 1 Press the **Utility** key, and select [DIAL REGISTRATION].

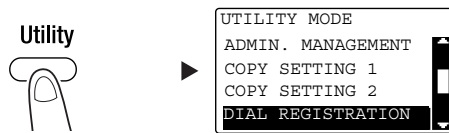

→ Use the ▲/▼ key to select it, then press the **OK** key.

- 2 Select [ONE-TOUCH DIAL].

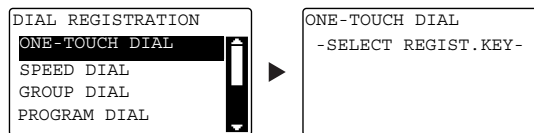

→ Use the ▲/▼ key to select it, then press the **OK** key.

- 3 Press the **One-Touch Dial Key** to register a destination in.

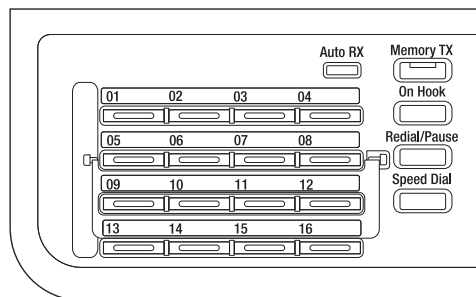

- Up to 32 stations can be registered in One-touch Dial.
- When the LDAP setting has been configured, select [MANUAL SETTING].

- 4 Enter the name and E-mail address of the destination using the **Keypad**, then press the **OK** key.

ONE-TOUCH DIAL 01 NAME : AAA TOKYO [A...]	▶	ONE-TOUCH DIAL 01 DESTINATION : Z [A...] OTHER SETTING=▼
---	---	---

- You can specify the transmission size, resolution, and other settings. For details, refer to Chapter 4 of the [User's Guide Scan].

Registering destinations in the speed dial

Register a destination in the speed dial; you can specify a destination easily and accurately without entering an E-mail address using the **Keypad**.

- 1 Press the **Utility** key, and select [DIAL REGISTRATION].



UTILITY MODE ADMIN. MANAGEMENT COPY SETTING 1 COPY SETTING 2 DIAL REGISTRATION	▶	▲▼
--	---	----

- Use the ▲/▼ key to select it, then press the **OK** key.

- 2 Select [SPEED DIAL].

DIAL REGISTRATION ONE-TOUCH DIAL SPEED DIAL GROUP DIAL PROGRAM DIAL	▶	▲▼
---	---	----

- Use the ▲/▼ key to select it, then press the **OK** key.

- 3 Enter a desired 3-digit speed dial number using the **Keypad**, then press the **OK** key.

```
SPEED DIAL
SPEED DIAL: 001

-PRESS OK KEY-
```

- Up to 250 stations (001 to 250) can be registered in the speed dial.
- When the LDAP setting has been configured, select [MANUAL SETTING].

- 4 Enter the name and E-mail address of the destination using the **Keypad**, then press the **OK** key.

```
SPEED DIAL 01
NAME
: AAA OSAKA [A...] ►
SPEED DIAL 01
DESTINATION
: xxx01@xxx.xxx [1...]
OTHER SETTING=▼
```

- To specify the transmission size, resolution, or other settings, refer to Chapter 4 of the [User's Guide Scan].

6.3 Canceling the ongoing transmission

This section describes the procedure for stopping the transmission that has been started by pressing the **Start** key.

- 1 Press the **Clear/Stop** key during transmission.
- 2 Use the **▲/▼** key to select [YES], then press the **OK** key.

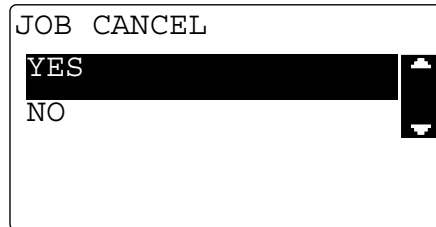

- Selecting [NO] restarts the transmission of the scanned data.
A transmission result report is printed out.

6.4 How to use Scan to USB

This chapter describes how to store scanned data on the USB memory.

- 1 Load the original.
 - For details on how to load the original, refer to page 2-11.
- 2 Connect a USB memory to this machine. The [DEVICE IS CONNECTED] screen appears.
- 3 Use the ▲/▼ key to select [SCAN TO USB], then press the **OK** key.
The machine mode changes to scan mode and [TO: Scan To USB Memory] is displayed.

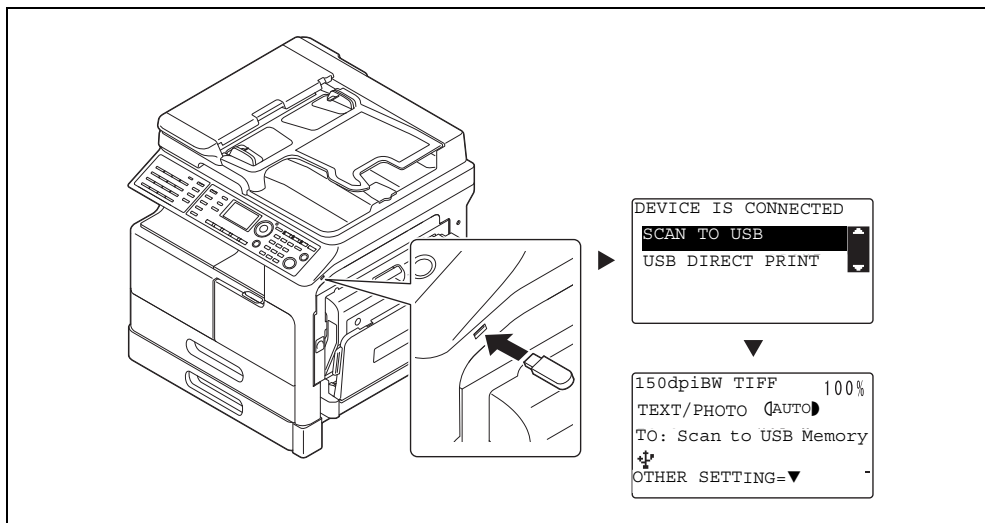

- The file format and compression coding method can be specified. For details, refer to Chapter 8 of the [User's Guide Scan].

- 4 Specify the resolution setting.

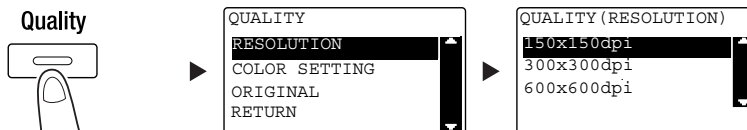

- Use the ▲/▼ key to select the correct setting, then press the **OK** key.
- Select [150×150dpi], [300×300dpi], or [600×600dpi].
- When [Color] or [Gray] is specified for the color setting, [600×600dpi] is not displayed.

5 Specify the color setting.

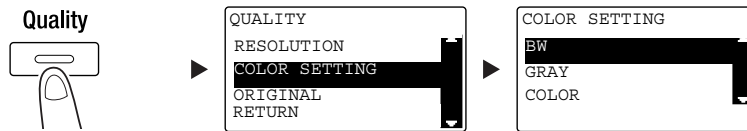

- Use the ▲/▼ key to select the correct setting, then press the **OK** key.
- Select [BW], [GRAY], or [COLOR].
- If [BW] is selected with [Image Format] set to [JPEG], [PDF] is automatically selected.

6 Specify the image quality.

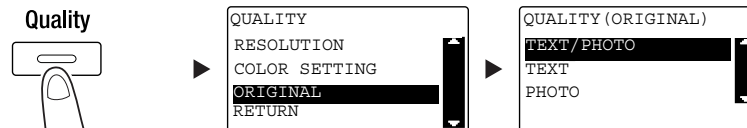

- Use the ▲/▼ key to select the correct setting, then press the **OK** key.
- Select [TEXT/PHOTO], [TEXT], or [PHOTO].

7 Press the **Start** key.

Scanned original is stored in the USB memory.

- When you have loaded the original onto the **Original Glass**, go to Step 7.

8 Use the ▲/▼ key to select [AUTO DETECTION] or [MANUAL], then press the **OK** key.

- When you select [MANUAL], you can specify the scanning size.

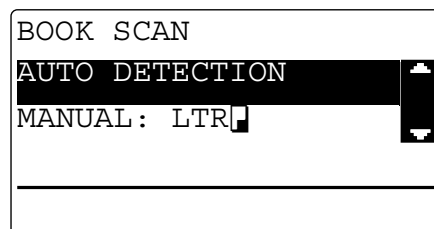

9 To start scanning, press the **OK** key.

10 When continuously scanning the original, load the next original, then press the **OK** key.

11 When scanning of all originals has been completed, press the **Start** key.

- To interrupt the transmission, press the **Clear/Stop** key then select [YES] in the displayed screen. For details, refer to page 6-10.

6.5 Scanning using a TWAIN driver

When a TWAIN driver is installed in your computer, you can use this machine to scan originals as data and import it into the computer.

In the "Pull Scan" method, scanning is started from the computer screen, and in the "Push Scan" method, scanning is started by pressing the **Start** key on this machine.

The operation method differs depending on the application to be used.

- 1 Load the original.
 - For details on how to load the original, refer to page 2-11.
- 2 Start the image processing application on the computer side.
- 3 Configure the scanning settings.
 - In [Document Size], specify the size of the original to be scanned.
If the image to be scanned is greater than the size specified in Original Size, the areas outside the specified size are deleted.
 - In [Scan Mode], specify the image quality of the original.
Switching [Scan Mode] displays icons. Press these icons to specify the color brightness or contrast.
 - In [Resolution], specify the resolution.
If [Scan Mode] is set to [Full Color] or [Gray], [600dpix600dpi] is not displayed.
 - In [Scan Type], specify the scanning method.
 - In [Duplex Scanning], turn on or off the 2-sided scanning function.
[Duplex Scanning] is displayed when the optional ADF is installed.
 - Click [Prescan] to display the scanned original in the pre-scan window.
- 4 Scan the original.
 - For Pull Scan, click [Scan]. Scanning starts.
 - For Push Scan, click [Scan] then press the **Start** key on the **Control Panel**. Scanning starts.

6.6 Scanning using a WIA driver

Scanning is enabled using an application that supports WIA.

The operation method differs depending on the application to be used.

- 1** Load the original.
 - For details on how to load the original, refer to page 2-11.
- 2** Start the image processing application on the computer side.
- 3** Configure the scanning settings.
 - For details on settings, refer to [User's Guide Scan].
- 4** Click [Scan].

Scanning starts.

7

Troubleshooting

7 Troubleshooting

This chapter describes troubleshooting operations against typical problems.

If the problem is not corrected after the described operation is performed, contact your service representative.

The power does not turn on

Check the following:

- Check that the power cord of this machine is correctly plugged into an outlet. Also check that the circuit breaker is not tripped.
- Check that the **power switch** is turned on.

Tips

If the power still does not turn on after checking, contact your service representative.

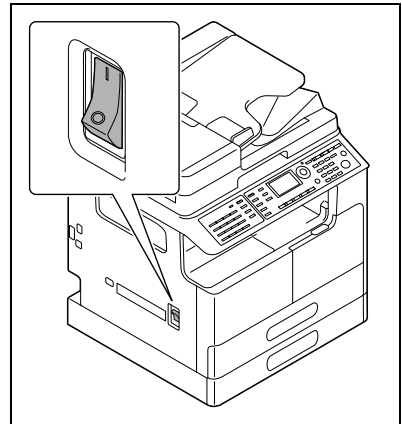

A message prompting you to replace consumables has appeared

When the remaining amount of a consumable item becomes low, a message is displayed to inform you of when to carry out a replacement.

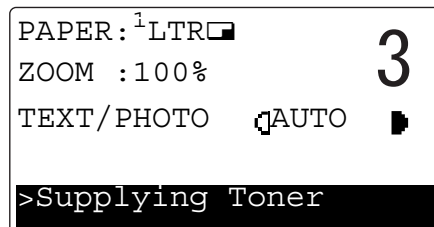

A message prompting replacement means that consumables are nearly exhausted. You can make several copies after the message is displayed. However, we recommend that you procure consumables before you need to use them.

Tips

If the message remains displayed after replacement, contact your service representative.

The paper jam message does not disappear

Another paper jam may have occurred in a location other than that indicated in the **Display**.

Check the locations other than that indicated in the **Display**.

- Check whether a piece of paper has not been removed from a deeper area of the location indicated in the **Display**. If it is difficult for you to remove the jammed paper, do not try too hard. Contact your service representative.
- The door may not be closed correctly. Open and close the door again in the location indicated in the **Display**. Doing this may cause the message to disappear.

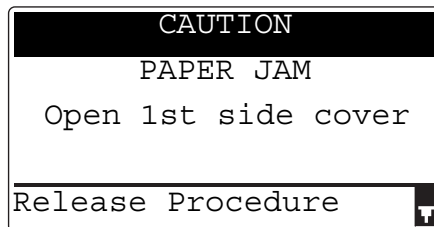

Tips

If the paper jam message still persists after checking, contact your service representative.

An error message has appeared

If there is a problem that cannot be remedied by the customer, the [MACHINE TROUBLE SERVICE CALL (C####)] message appears.

In the Service Call screen, an error code that usually begins with C appears.

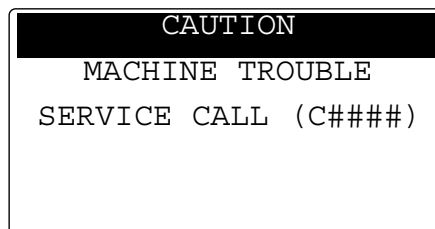

If this message appears in the **Display**, turn off the **power switch**, wait for about 10 seconds, then turn on the **power switch** again.

If the message remains displayed, check the error code displayed in the **Display**, disconnect the power cord from the outlet, then contact your service representative.



8 Utility

8 Utility

In Utility, you can specify the default value of each function to meet your conditions or environment.

To change the settings, press the **Utility** key on the **Control Panel**.

No.	Name	Description
1	[MACHINE SETTING]	Configure the settings for the operating environment of this machine.
2	[PAPER SOURCE SET-UP]	Specify the size and type of the paper loaded in Tray 1 . You can also specify the unit of paper size and paper type loaded in Tray2-Tray5 .
3	[CUSTOM SIZE MEMORY]	Register up to two custom sizes.
4	[DRUM DEHUMIDIFY]	Performs the drum drying operation to remove dew condensation around the PC of the photo conductor, preventing deterioration of functions.
5	[ADMIN. MANAGEMENT]	Configure the remote monitor settings or settings for the administrator to manage each account.
6	[COPY SETTING 1]	Configure the default settings for each copy function.
7	[COPY SETTING 2]	
8	[DIAL REGISTRATION]	Register destinations in One-touch Dial, speed dial, and group dial.
9	[FAX REGISTRATION]	Configure the default settings for each fax function.
10	[FAX TX OPERATION]	Configure the default settings for transmission operations.
11	[FAX RX OPERATION]	Configure the default settings for receiving operations.
12	[REPORTING]	Configure the default settings for each report function.
13	[SCAN SETTING]	Configure the default settings for the scan function.
14	[CONFIRM MODE]	Confirm the counter or communication result, or print out a report.

Tips

- Some items cannot be configured depending on which optional device is installed in this machine. If an unavailable item is selected, an error message appears.
- For details, refer to the relevant operation guide.

9

Index

9 Index

Numerics

2-sided Copy 3-5
2-Sided Print 5-5

A

Access 2-7
AddressBook 2-6
ADF 2-12
Auto RX Indicator 2-8
Automatic Duplex Unit AD-509 2-22

B

Bypass Tray 2-15

C

Clear/Stop 2-7
Combine Original 2-6
Combined Copy 3-6
Combined Print 5-6
Control Panel 2-6
Copy 2-7, 3-3
Custom Size Copy 3-7
Custom Size Print 5-7

D

Density 2-6
Desk DK-706 2-22
Desk DK-707 2-23
Desk DK-708 2-23
Destination settings 4-12
Display 2-6

E

E-Mail TX 6-3
Entering characters 4-10
Envelope 3-9, 5-13
Extended Operation Panel MK-750 2-23

F

Fax 2-7
Fax communication results 4-6
FAX Kit FK-510 2-23
Finishing 2-6
Fixed Zoom 3-4
FTP/SMB TX 6-5
Function 2-6

I

ID Copy 2-6

K

Keypad 2-7

L

Loading paper 2-13

M

Main unit 2-22
Manual Zoom 3-4
Memory TX 2-8
Mode Memory 2-6

O

On Hook 2-8
One-Touch Dial Key 2-8
Option configuration 2-22
Original Cover OC-512 2-22
Original Glass 2-11
Original Set 2-11

P

Paper 2-6
Paper Feeder Unit PF-507 2-22
PC-FAX 4-13
Power Save 2-6
Print 5-3
Printer 2-7
Printer Indicator 2-7

Q

Quality 2-6

R

Redial/Pause 2-8
Registering the one-touch dial 4-7, 6-7
Registering the speed dial 4-8, 6-8
Removing a jam 2-16
Removing a jam in the Automatic Duplex Unit 2-19
Replacing consumables 2-20
Reset 2-7
Reverse Automatic Document Feeder DF-633 2-22

S

Safety information 1-5
Scale Printing 5-4
Scan 2-7
Scan to USB 6-11
Sending a fax 4-3
Sending scanned data 6-3
Sequential broadcast transmission 4-5
Simplex/Duplex 2-6
Speed Dial 2-8
Start 2-7
Stopping fax transmission 4-11
Stopping scanned data transmission 6-10
Stopping the copy operation 3-10
Switching Plate 2-8

T

Tray 1 2-13

Tray 2 2-14

Tray 3 2-14

Tray 4 2-14

Tray 5 2-14

Troubleshooting 7-3

Turning the power on/off 2-10

TWAIN driver 6-13

U

Utility 2-6, 8-3

W

WIA driver 6-14

Z

Zoom 2-6, 2-9